



2024-2025



www.myc.org.au

HANDBOOK & SAILING PROGRAM



THE KITCHEN MAKER

CUSTOM KITCHENS & JOINERY



Local Sponsors of
Manly Yacht Club
Juniors



- Ph: 02 9905 5028
- Fax: 02 9939 5978
- Email: info@thekitchenmaker.com.au
- Address: 3/228 Harbord Road, Brookvale NSW 2100





**HANDBOOK
AND
SAILING PROGRAM
2024-2025**

Front Cover: Goodbye *Carlyle*, hello *Ready, Get Set!!!* / Image by Marg Fraser-Martin

CONTENTS

1. CONTACT DETAILS.....	5
1.1. MANLY YACHT CLUB.....	5
1.2. EMERGENCY AND BOATING SERVICES.....	5
1.3. BOARD OF DIRECTORS.....	6
1.4. OTHER CONTACTS.....	6
1.5. SAILING COMMITTEE.....	7
1.6. MEMBERSHIP AND SOCIAL COMMITTEE.....	8
1.7. CLUB COMMITTEE.....	8
1.8. VOLUNTEERING.....	9
2. MYC INTRODUCTION.....	10
2.1. MYC VISION, MISSION AND VALUES.....	10
2.2. MYC GOVERNANCE.....	11
2.3. MYC BY-LAWS.....	12
2.4. MEMBER PROTECTION POLICY.....	14
2.5. MYC ALCOHOL POLICY.....	14
2.6. MYC PRIVACY STATEMENT.....	15
3. ABBREVIATIONS.....	16
3.1. THIS HANDBOOK.....	16
3.2. OTHER SYDNEY CLUBS.....	16
4. MEMBERSHIP AND FACILITIES.....	17
4.1. SCHEDULE OF FEES.....	17
4.2. BOAT STORAGE.....	19
4.3. MYC COURTESY DINGHIES / TENDER SERVICE.....	20
4.4. MYC WHARF AND MOORINGS.....	20
4.5. MYC SUPPORT BOATS.....	22
4.6. MYC BBQ DECK and BAR.....	22
4.7. WORKING BEES.....	22
4.8. TRAINING.....	23
4.9. VENUE HIRE.....	24
5. SAILING AT MYC.....	25
5.1. RACE FEES.....	25
5.2. RACE MANAGEMENT ROSTER.....	25
5.3. YACHTS.....	26
5.4. ILCAS.....	27
5.5. JUNIOR AND YOUTH.....	27
5.6. SAILABILITY.....	27
5.7. LEARN TO SAIL.....	28
5.8. MYC CALENDAR.....	30
5.9. TROPHIES AND PRESENTATIONS.....	34
5.10. MYC YACHT REGISTRY.....	36
5.11. YACHT SPOTTERS GUIDE.....	37
5.12. ILCA SPOTTERS GUIDE.....	38
5.13. SAILABILITY SPOTTERS GUIDE.....	39
5.14. MYC OWNED JUNIOR FLEET.....	39
5.15. RISK WARNING.....	40
5.16. RISK ASSESSMENT.....	41
5.17. SAFETY PLAN FOR COMPETITORS.....	43
5.18. EMERGENCY COMMUNICATIONS.....	44
5.19. INCIDENT REPORTING.....	45
5.20. STRONG WIND ABANDONMENT GUIDELINES.....	46
5.21. DECK, BOATS AND ACTION PLAN.....	48

5.22.	DECK RIGGING PLAN	51
5.23.	ON WATER MANAGEMENT	51
6.	MYC JUNIOR AND YOUTH PROGRAM.....	53
6.1.	INTRODUCTION	53
6.2.	JUNIOR AND YOUTH BOATS SAILED.....	53
6.3.	CLUB-OWNED BOATS.....	53
6.4.	PRIVATELY-OWNED BOATS.....	53
6.5.	SAILING PATHWAYS AT MYC.....	54
6.6.	NEW RECRUITS	56
6.7.	PARENTS INDUCTION COURSE.....	56
6.8.	JUNIORS PRE-REQUISITES	56
6.9.	JUNIORS GEAR (WHAT TO BRING WITH THEM).....	56
6.10.	COMMUNICATIONS.....	57
6.11.	RACING FLEETS.....	57
6.12.	PARENTAL PARTICIPATION AND THE MANAGEMENT FRAMEWORK	58
6.13.	GENERAL CONDITIONS OF RACING FOR JUNIOR & YOUTH FLEETS.....	61
6.14.	ON DECK MANAGEMENT	62
7.	GENERAL CONDITIONS OF RACING.....	66
7.1.	RULES.....	66
7.2.	ELIGIBILITY AND ENTRY	66
7.3.	EQUIPMENT AUDIT	66
7.4.	NOTICE TO COMPETITORS	67
7.5.	SAILING INSTRUCTIONS.....	67
7.6.	SIGNALS MADE ASHORE.....	67
7.7.	MARKS.....	67
7.8.	AREAS THAT ARE OBSTRUCTIONS.....	67
7.9.	RACE FORMATS	68
7.10.	THE START (COMMITTEE VESSEL)	68
7.11.	THE START (CLUBHOUSE TRIANGLES).....	68
7.12.	THE START (SCRATCH RACE, TCF RACE)	69
7.13.	THE START (PURSUIT RACE & PURSUIT TCF RACE)	69
7.14.	THE FINISH (COMMITTEE VESSEL).....	69
7.15.	THE FINISH (CLUBHOUSE TRIANGLES)	70
7.16.	HANDICAPS AND DIVISIONS.....	70
7.17.	PHS HANDICAPS - SAILSYS RACE MANAGEMENT SYSTEM.....	71
7.18.	PENALTY SYSTEM	71
7.19.	PROTESTS, ARBITRATION AND REDRESS.....	71
7.20.	USE OF PROPULSION	72
7.21.	SCORING.....	72
7.22.	RESULTS.....	73
7.23.	SAFETY REGULATIONS.....	73
7.24.	PRIZES AND TROPHIES.....	74
7.25.	DISCLAIMER OF LIABILITY.....	74
7.26.	INSURANCE.....	74
7.27.	SAIL NUMBERS	74
7.28.	RACE COMMITTEE.....	74
7.29.	CLUB REPRESENTATION	74
7.30.	DUTY BOAT.....	75
8.	SAILABILITY NOR & SI	77
	SAILABILITY REGATTAS – NOR.....	77
	SAILABILITY REGATTAS – SI.....	78

9. JUNIOR & YOUTH NOR & SI	81
JUNIOR & YOUTH CLUB CHAMPIONSHIP – NOR.....	81
JUNIOR & YOUTH CLUB CHAMPIONSHIP – SI.....	82
JUNIOR & YOUTH HANDICAP POINT SCORES – NOR.....	83
JUNIOR & YOUTH HANDICAP POINT SCORES – SI.....	84
JUNIOR & YOUTH MINI REGATTA – NOR.....	87
JUNIOR & YOUTH MINI REGATTA – SI.....	88
JUNIOR & YOUTH DESTINATION RACE – NOR.....	89
JUNIOR & YOUTH DESTINATION RACE – SI.....	90
10. ILCA NOR & SI	91
ILCA MICRO REGATTA – NOR.....	91
ILCA MICRO REGATTA – SI.....	92
ILCA CHAMPIONSHIP & POINT SCORES – NOR.....	94
ILCA CHAMPIONSHIP & POINT SCORES – SI.....	95
11. YACHT NOR & SI.....	98
YACHT CHRISTMAS – NOR.....	98
YACHT CHRISTMAS – SI.....	99
YACHT CLUB CHAMPIONSHIP – NOR.....	101
COMBINED CLUBS SUNDAY SERIES.....	103
YACHT MANLY SPRINT SERIES – NOR.....	109
YACHT MARATHON SERIES – NOR.....	110
YACHT MARATHON SERIES – SI.....	111
YACHT OFFSHORE SERIES.....	112
YACHT SUMMER SERIES – NOR.....	113
YACHT SUMMER SERIES – SI.....	114
YACHT TWILIGHT SERIES – NOR.....	115
YACHT TWILIGHT SERIES – SI.....	116
YACHT WINTER SERIES – NOR.....	118
YACHT WINTER SERIES – SI.....	119
WOMEN'S CHALLENGE.....	121
12. APPENDICES.....	122
A1 JUNIOR & YOUTH COURSES.....	122
A2 ILCA COURSES.....	125
A3 CLUB CHAMPIONSHIP & COMBINED CLUBS SUNDAY SERIES DIVISION 1 COURSES.....	129
A4 CLUB CHAMPIONSHIP & COMBINED CLUBS SUNDAY SERIES DIVISION 2 COURSES.....	130
A5 YACHT TWILIGHT COURSES.....	131
A6 YACHT SUMMER SERIES COURSES.....	132
A7 YACHT MARATHONS DIVISION 1 AND 2 COURSES.....	133
A8 YACHT WINTER SERIES DIVISION 1 COURSES.....	134
A9 YACHT WINTER SERIES DIVISION 2 COURSES.....	135
A10 YACHT MANLY SPRINT SERIES COURSES.....	136
13. SPONSORS AND ADVERTISERS INDEX	137

1. CONTACT DETAILS

1.1. MANLY YACHT CLUB

ABN: 12 000 489 421
 Telephone: (02) 9977 4949
 Radio: VHF 72
 Street Address: East Esplanade, Manly 2095
 Postal Address: PO Box 22, Manly 1655
 Nautical Address: East Shore, Manly Cove
 Web: <http://www.myc.org.au>
 General Enquiries: info@myc.org.au
 Club Manager: manager@myc.org.au
 MYC Membership: membership@myc.org.au
 MYC Sailing Office: sailing@myc.org.au
 Official Notice Board: MYC Website and WhatsApp for Juniors

1.2. EMERGENCY AND BOATING SERVICES

Emergency Services: 000 or VHF Ch16
 Water Police: 9320 7499 (Use 000 for any incidents)
 Marine Rescue NSW: 8071 4848 or VHF Ch16
 Manly Police: 9976 8099 (Use 000 for any incidents)
 Transport for NSW: 13 22 13
 Australian Sailing: www.sailing.org.au
www.sailingresources.org.au
 Harbour Control: VHF Ch13
 Weather Information: <http://www.bom.gov.au/marine>
 Spit Bridge Opening Times: <https://www.nsw.gov.au/driving-boating-and-transport/navigation-and-communication/spit-bridge-openings#toc-bridge-opening-times>

TREHARNE MOORINGS

SYDNEY HARBOUR
EST.1945

CALL ROBBIE ON (02) 9948 7787

info@treharnemoorings.com.au www.treharnemoorings.com.au

1.3. BOARD OF DIRECTORS

TITLE	NAME	EMAIL	PHONE
President	Lisa Callaghan	president@myc.org.au	0415 124 227
Vice President			
Treasurer	David Lewis	treasurer@myc.org.au	0411 883 475
Commodore	Stephen Teudt	commodore@myc.org.au	0411 262 121
Vice Commodore	Catherine Thornton-Rofe	vicecommodore@myc.org.au	0409 600 791
Club Captain	Bruce Davis	club.captain@myc.org.au	0413 397 502
Membership	Maz Radford	maz@myc.org.au	0427 244 726

1.4. OTHER CONTACTS

TITLE	NAME	EMAIL	PHONE
Club Manager	Barry Mifflin	manager@myc.org.au	0415 783 910
Bookkeeper	Janette Pitt	bookkeeper@myc.org.au	
Head Coach	Johanna Bergqvist	juniors@myc.org.au	
Licensee	Stephen Teudt	licensee@myc.org.au	0411 262 121
Manly Sailability President	Warwick McKenzie	warwickmckenzie@yahoo.com.au	0416 295 461
Manly Sailability Secretary	Stephen Bush	secretary@manlysailability.com.au	0413 368 173
Venue Hire	Kim English	venuehire@myc.org.au	0432 901 125

Auditor Brooks, Deane & Powne
Level 14, 60 Carrington St
Sydney 2001
Tel. 02 9233 6111

Bank Commonwealth Bank, The Corso
Manly 2095
BSB: 062 197
ACC: 2802 4001



Like MYC on: <http://facebook.com/ManlyYachtClub>

1.5. SAILING COMMITTEE

TITLE	NAME	EMAIL	PHONE
The Sailing Committee		sailingcommittee@myc.org.au	
Sailing Office		sailing@myc.org.au	
Commodore	Stephen Teudt	commodore@myc.org.au	0411 262 121
Vice Commodore	Catherine Thornton-Rofe	vicecommodore@myc.org.au	0409 600 791
Rear Commodore	Jason Bond	rearcommodore@myc.org.au	0435 121 289
Sailing Administrator	Jan Bartel	sailingadmin@myc.org.au	0417 786 635
Principal Handicapper	Greg Wilkins	handicaps@myc.org.au	0417 786 631
Principal Race Officer	Stephen Teudt	pro@myc.org.au	0411 262 121
Chief Equipment Auditor	Arthur Crothers	auditor@myc.org.au	0402 142 305
Crew Coordinator		mycrew@myc.org.au	
Duty Roster Coordinator	Anne Immerglück	dutyroster@myc.org.au	
Trophies and Awards	Tomas Kliman		0419 392 176
Sponsorship		sponsorship@myc.org.au	
Juniors RD	Geoff Gill	juniors@myc.org.au	
ILCA RD	Tim Docker	lasers@myc.org.au	0414 937 654
Christmas Race RD		sailing@myc.org.au	
Club Championship RD	Mark Stacey	clubchampionship@myc.org.au	0404 017 440
Marathon Series RD		marathonseries@myc.org.au	
Manly Sprint Series RD	Catherine Thornton-Rofe	miniregatta@myc.org.au	0409 600 791
Offshore Racing RD	Stephen Teudt	offshoreseries@myc.org.au	0411 262 121
Summer Series RD	David Ashton	summerseries@myc.org.au	0417 691 197
Twilight Series RD	Jason Bond	twilightseries@myc.org.au	0435 121 289
Winter Series RD	Greg Wilkins	winterseries@myc.org.au	0417 786 631
Women's Challenge RD	Catherine Thornton-Rofe	womenschallenge@myc.org.au	0409 600 791

RD = Race Director, the principal point of contact regarding that particular race or series.

Equipment Auditors:

Arthur Crothers (NEA)	0402 142 305	Kimball Mann (NEA)	0476 591 100
Carlos Aydos	0401 376 500	Muir Watson	0407 229 667
Catherine Thornton-Rofe	0409 600 791	Nick Polin	0414 665 678
David Wright	0418 244 006	Peter Bennell	0418 618 289
Graeme Gaggin	0478 630 856	Stephen Teudt	0411 262 121
Jason Bond	0435 121 289		

Contact commodore@myc.org.au if you require an endorsement letter to attend an Australian Sailing course.

1.6. MEMBERSHIP AND SOCIAL COMMITTEE

TITLE	NAME	EMAIL	PHONE
Membership Director	Maz Radford	maz@myc.org.au	0427 244726
Vice President			
Membership Administrator	Nadine McBain	membership@myc.org.au	0411 865 824
Social Director	Robert Morley	remorley@gmail.com	0402 748 142
Newsletter Editor	Maz Radford	newsletter@myc.org.au	0427 244 726
Webmaster	Bob Day	webmaster@myc.org.au	
Pathways Coordinator			
Social Media Coordinator			
Diversity and Inclusion			
Historian			

1.7. CLUB COMMITTEE

TITLE	NAME	EMAIL	PHONE
Club Captain	Bruce Davis	club.captain@myc.org.au	0413 397 502
Treasurer	David Lewis	treasurer@myc.org.au	0411883 475
Club Manager	Barry Mifflin	manager@myc.org.au	0415 783 910
Grants Officer	Brad Van Dijk	grants@myc.org.au	0409 779 508
Boats Captain			
Equipment Captain			
Tender Service Captain			
Sustainability Officer			
OHS Officer			

1.8. VOLUNTEERING

MYC completely relies on volunteers in order to run its race program. No volunteers mean no events. So, please do your bit and help out for a day as a Race Volunteer assisting with the starting sequence, recording finish times, etc. Contact the Duty Roster Coordinator and make yourself available. Every active member should aim to volunteer once or more for these duties during the course of the season.

Alternatively, if you'd like to help organise the sailing operations of the Club, then please contact the Commodore and we will find a role for you on the Sailing Committee, which meets one evening each month.

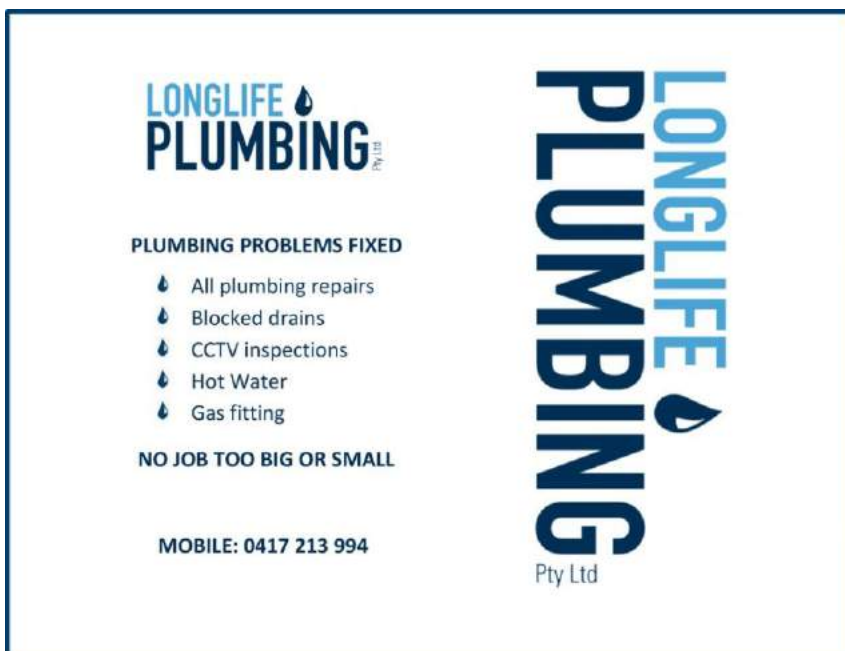

LOGLIFE
PLUMBING Pty Ltd

PLUMBING PROBLEMS FIXED

- 🔧 All plumbing repairs
- 🔧 Blocked drains
- 🔧 CCTV inspections
- 🔧 Hot Water
- 🔧 Gas fitting

NO JOB TOO BIG OR SMALL

MOBILE: 0417 213 994

LOGLIFE
PLUMBING Pty Ltd

2. MYC INTRODUCTION

MYC is a community-oriented club that provides friendly, competitive sailing on Sydney Harbour for yachts, ILCAs, junior dinghies and a branch of Sailability for mobility impaired sailors.

MYC is an organisation run by the members for the members, and you are encouraged to become involved in any way you feel able, both on and off the water. If you are new to sailing or racing, our Twilight series is a great way to get started and coming back to the Club afterwards for a drink and a bite to eat is a great way to meet other members.

If you have any questions or any problems, feel free to seek out a Board member or Sailing Committee member and we will be happy to help. And don't forget to check our website for upcoming training courses.

This handbook contains sailing information for the current MYC season. The handbook contains general information, by-laws, policies, MYC Notices of Race, MYC Sailing Instructions and other general MYC sailing information.

Please take the time to read your handbook carefully. It will pay dividends.

2.1. MYC VISION, MISSION AND VALUES

Our Vision

Manly Yacht Club is a fun and friendly family-oriented sports club with a long history, run for the benefit of the local community, that welcomes sailors of all abilities to stay active and healthy while enjoying the waters of beautiful Manly Cove and Sydney Harbour.

Our Mission

To achieve our vision, we will:

- Manage a wide range of sailing events for the benefit of Club members and the sailing community at large;
- Be a valued member of the local community by providing a positive and sustainable contribution and amenity to the surrounding area and environment; and
- Promote a culture where all members, guests and volunteers work together in a positive, and friendly atmosphere for the benefit of the Club whilst encouraging diversity and respect.

Our Values

- **Community-Minded and Considerate** – We will continue our proud tradition of benefiting the local community and supporting sailors of all abilities while remaining considerate of the needs of our members, guests, volunteers and the local community and environment.
- **Friendly and Inclusive** – We will encourage a friendly and fun atmosphere for members, guests and volunteers alike, while welcoming all people regardless of their age, gender, abilities, ethnicity and/or religion.
- **Active and Spirited** – We will remain a volunteer-based organisation that expects the active participation of all our members in the same spirit as those members who have so generously contributed their time and effort to build our proud history.

2.2. MYC GOVERNANCE

The Board

Manly Yacht Club is incorporated as a limited liability not-for-profit company, which is overseen by the Board of Directors:

- The **President** convenes the Board Meetings, sets the agenda and is ultimately responsible for the financial running of the Club.
- The **Treasurer** manages the Club's finances and supervises the bookkeeper.
- The **Club Captain** manages the Club's off water sailing assets (jetty, boat storage, etc) and the maintenance of the Club's floating assets.
- The **Commodore** and **Vice Commodore** represent the Sailing Committee on the Board.

Employees and Service Providers

The Board of Directors is responsible for supervising the work of our paid employees and service providers:

- The **Club Manager** deals with matters such as security, insurance, bills, quotes, tradesmen, supplies, council, and oversees the maintenance of the club.
- The **Bookkeeper** handles the Club's accounting system and banking.
- The **Venue Hire Service Provider** operates the Club's venue hire business and provides the Club with a valuable source of revenue.
- **Manly Sailing** is a tenant that rents the sailing office and provides a learn-to-sail service for juniors and adults plus a yacht charter and holiday service.
- **Head Coach** manages the junior and youth sailing.
- The **Sailing Instructors** are employed casually for the junior racing fleets.
- **Professional RSAs** are employed for Twilight race nights and special events to free up our qualified volunteer members.

Sailing Committee

The sailing operations of the Club are managed by the Sailing Committee and the Race Directors that report to it:

- The **Commodore** ensures that the Club complies with the terms of its Aquatic Licence (and related regulatory exemptions) issued by Transport for NSW (TfNSW). This requires the Club to specify its operating procedures, safety plan and duty of care and chain of command for all on water activities. The primary mechanism for enacting these operating procedures is the Sailing Committee, which is convened and run by the Commodore.
- The **Rear Commodore** is the previous holder of the Commodore role and provides advice and assistance to the Commodore.
- The **Vice Commodore** is the Commodore in training and acts to assist the Commodore.
- Each race series is managed off the water by a **Race Director**, who writes the Notice of Race (NOR) and Sailing Instructions (SI), organises a Race Committee (RC) to manage the on-water activities of each race day and processes the race results.
- The **Sailing Administrator** manages the race entry system and checks the insurance, payments and audit certificates of all entries.
- The **Principal Race Officer** supervises the training and quality of the Club's Race Officers and race procedures.

Race Committees

On each race day, the Race Director hands over to the Race Committee:

- The **Race Officer** is the individual responsible for all racing on a given day and makes the decisions about course selection, starts/finishes, abandonment, etc. They may be advised by the Principal Race Officer, Race Director, Principal Handicapper and/or Commodore(s). In particular, although the final decision rests with the Race Officer, they should consult with one or more of these individuals before making the course selection.
- The **Race Officer Assistants** are the Race Committee members who raise and lower flag sequences and record the time and order that boats cross the start/finish line as directed by the Race Officer, either on the committee vessel or the MYC upper deck.
- The support boat will have 1 or 2 Race Committee members who drive the boat, lay marks, relay messages and people and stand by to assist if possible, in an emergency, however it is not a rescue boat.

2.3. MYC BY-LAWS

Introduction to MYC By-Laws:

It is a requirement of every member to comply with the by-laws at all times.

These by-laws may be changed from time to time by the Board of Directors of MYC.

Failure to comply with these by-laws may result in disciplinary action being taken by the Board of Directors. This action may result in loss of MYC membership.

Preamble:

MYC is a primarily volunteer run non-profit organisation. Its corporate structure is that of a company limited by guarantee and not having share capital. MYC leases the land and the clubhouse from Northern Beaches Council (NBC); and sub-leases via the NBC from TfNSW. It shares the use of the clubhouse with the Manly Diggers Swimming Club and make its facilities available to other community groups.

For various reasons, MYC is unable to expand to become a self-supporting commercial concern able to pay for all outgoings and services. These circumstances include:

- Council support for a community-based organisation that does not have a commercial liquor licence or gaming machines.
- Limitations on parking in the local area.
- The closeness of residential neighbours and a requirement to limit noise and other disruption.

Therefore, if MYC is to continue to exist, it must continue as a primarily volunteer run, non-profit organisation.

Input by volunteers is essential to the continued operation of MYC and helps to keep membership fees and other charges low.

By-Laws:

1. It is a responsibility of all members of MYC to assist with the operation of the Club by providing services free of charge. These services may include management, administration, club operations, repairs and maintenance or other services.
2. Volunteers **MUST** be treated with respect at MYC. Any member who does not show volunteers appropriate respect or criticises the work of volunteers at MYC may be subject to disciplinary action and may have their membership revoked. If you think you can do a job better than an existing volunteer, give it a go!
3. At the end of all Club events and functions, the area used must have rubbish and recyclable materials removed and furniture and equipment put away.
4. Members must place waste and recyclable materials in the appropriate bins provided on the eastern side of the clubhouse at ground level.

5. Club security is critical as the Club does not have staff present at all times. Every member is entitled to have a key to the deck and common facilities. Therefore, doors MUST be kept locked at all times other than during scheduled events. It is a responsibility of members to lock all doors that are opened or are found to be open at times other than during scheduled events. All people entitled to enter the premises and use the facilities will have a key. General access keys and full Club-access master keys and security codes are managed by the Club Manager.
6. Guests may only enter MYC in the company of members. Members will be held responsible for the behaviour of their guests and must advise the guests that the Club is a volunteer-run Club. Guests must extend the same respect to volunteers as members are required to.
7. Members and guests must act in a responsible manner and not do anything that will offend or put other members or guests at risk.
8. Maritime environments have particular risks including uneven surfaces, movement from wave action, water of varying depths, wharves and pontoons etc. Members and guests shall act responsibly after assessing the risks associated with the environment and facilities at MYC. Members shall ensure that their guests are aware of all risks.
9. Children must be supervised at all times by their parents and / or the inviting member. It should be noted that Club events and training are NOT child minding. Parents are required to assist with event management and / or the supervision of their children.
10. Jumping or diving from the wharf and running on the wharf or pontoon are strictly prohibited.
11. Scheduled events listed in the MYC Handbook and activities that bring income into the Club (e.g. use of the wharf by Pro Dive etc.) shall take precedence over use of facilities by individual members.
12. The storage of boats shall be in accordance with the requirements of the Club Captain. Members will be allocated a numbered boat storage location and must ensure that their boat is stored safely within that location. No boats shall be stored in a manner that restricts access to safety equipment (fire hose reels, extinguishers etc.) or to other boats or access ways.
13. To help limit theft from moored boats, oars must NOT be stored with dinghies or stored boats. ALL oars etc. MUST be stored in an allocated location in the oars rack.
14. Members must not store petrol or other flammable or dangerous goods within MYC premises. The fuel locker on the MYC rigging deck is solely for the storing of fuel for MYC support boats.
15. The MYC wharf is for use under the direction of the Club Captain, by vessels used in association with approved activities and events, including:
 - MYC and Sailability events
 - MYC members' private sailing
 - MYC sub lessees approved activities
 - Emergencies
 - others with prior permission of the Club Captain.
16. Northern Beaches Council has put in place noise restrictions to prevent or minimise nuisance to neighbours. These restrictions include the limitation of live or amplified music, stopping of music at 11:30 PM on weekends and at an earlier time during the week. Members shall become familiar with these restrictions if using the Club in the evenings and shall ensure that all restrictions are fully complied with.
17. Members using the Club shall minimise disruption to neighbours due to their use of the Club and when vacating the Club. Members are responsible for ensuring that members and their guests leave the Club quietly. Club property may not be used by Club members or others for private events, or be taken from Club premises on loan, without the approval of the Board or the delegated representative of the Board.

2.4. MEMBER PROTECTION POLICY

The Manly Yacht Club intentionally fosters sailing activities for its members. It provides facilities, boats, yachts, training and social programs in a harmonious environment.

One of the Club's Values is to be RESPECTFUL. We will respect all people and be considerate of the needs of our members, guests, partners, our community and our environment.

The main objective of the Member Protection Policy is to maintain responsible behaviour and to support informed decisions by members and other participants in this Club. It outlines our commitment to a person's right to be treated with respect and dignity, and to be safe and protected from discrimination, harassment and abuse. Our policy informs everyone involved in our club of his or her legal and ethical rights and responsibilities and the standards of behaviour that are required of them. It also covers the care and protection of children participating in our club's activities.

A copy of the policy, which includes a form to report an incident, is available on the MYC website www.myc.org.au.

2.5. MYC ALCOHOL POLICY

MYC offers a range of facilities for members and guests. These include: The bar, which stocks a range of wines and beers, as well as a selection of non-alcoholic drinks and low-alcohol beers.

NOTE: THAT THE BAR IS OPEN FOR RESTRICTED PERIODS, TO CATER FOR A LIMITED NUMBER OF CLUB-RELATED EVENTS ONLY. MYC IS NOT A LICENSED PREMISES, AND WE CANNOT SERVE ALCOHOL AS PART OF OUR HALL HIRE ACTIVITIES. THOSE HIRING THE HALL WILL HAVE TO MAKE THEIR OWN ARRANGEMENTS IN RELATION TO PROVISION OF FOOD AND REFRESHMENTS.

MYC has a policy to serve its members and guests in a responsible manner.

MYC is a community club, managed voluntarily by committed members. In keeping with our aim to remain a volunteer-managed community club we have arranged for our members to undertake recognised Responsible Service of Alcohol (RSA) training and certification.

Our bar is staffed by member-volunteers who hold RSA certification. RSA certified member volunteers are on hand to assist members and guests in their decision to drink in moderation and where appropriate to help avoid the dilemmas of combining drinking with driving. Staff will not serve any person under the age of 18 years, nor any patron who is intoxicated.

- No liquor will be served to minors (under 18 years of age).
- Intoxicated persons will be refused service of liquor.
- We recognise that it is against the Law to allow intoxicated, disruptive or violent behaviour to occur on the premises.
- We seek to ensure that no harm comes to members and guests as a result of our service of alcohol.

Our aim is to provide all members and guests with a venue for Club functions and post-sailing social activities. Consequently, the following policies and procedures have been adopted to ensure the Responsible Service of Alcohol:

- A range of drinks is offered on the premises, including a range of non-alcoholic drinks.
- Food is available whenever alcohol is served.
- Non-alcoholic beverages are priced and actively promoted.
- Water is provided on a complimentary basis.
- We do not encourage rapid or excessive consumption of alcohol.
- Low alcohol beers and mixed drinks are always stocked.
- Member-volunteers have been acquainted with the House policy and empowered to offer a range of options as an alternative to alcohol if they feel a patron is becoming intoxicated.
- Member-volunteers will contact the Licensee and alert them to patrons' impending state of intoxication.
- RSA-certified member-volunteers will determine whether or not service should be refused.

- If Service is refused, the RSA-certified member-volunteer will politely explain to the patron(s) that the premises cannot legally serve alcohol to the point of intoxication.

2.6. MYC PRIVACY STATEMENT

MYC is subject to the provisions of the Privacy Act 1988 and the Club has a commitment to privacy and safeguarding personal information of members. Any personal information you provide to MYC will be used only for those purposes for which it was gathered, and related purposes which can be reasonably expected.

MYC will not disclose any personally identifiable information obtained from you to other parties or for purposes other than those stated above, unless you provide your written consent to us, with the following exceptions:

- Information provided to Australian Sailing for the purposes of membership.
- Where there are grounds to believe that disclosure is required in order to prevent a threat to health or life.
- Where the use is authorised by law or reasonably necessary to enforce the law.

Member details are stored in RevolutioniseSPORT ("RevSport") and is accessible to members to update their own details.

Access is kept to named individuals based on role requirements.

- Board
- Club Administrators

Skippers details (as extracted from RevSport) are also stored in a secure directory for the use of Race Directors, if required in an emergency.

Access is reviewed at least annually to ensure it is appropriate.

Should your contact details change, or if you have any queries or concerns about your personal information, or if you wish your personal information held by MYC to be deleted, please inform MYC via membership@myc.org.au.



EST. 1945

• DESTINATION MARINA • MOORING RENTALS
• KAYAK STORAGE • SHIPWRIGHT SERVICES

1B Bolingbroke Parade, FAIRLIGHT NSW 2094

(02) 9948 3473

info@manlyboatshed.com www.manlyboatshed.com

3. ABBREVIATIONS

3.1. THIS HANDBOOK

AS	Australian Sailing
BOM	Bureau of Meteorology
COLREGS	Regulations for the Prevention of Collision at Sea
DCF	Distance Correction Factor
DSC	Digital Selective Calling (for VHF alerts)
EPIRB	Emergency Position-Indicating Radio Beacon
EWS	Early Warning Signal
F11	Flying 11
HC	Handicap
ILCA	International Laser Class Association
IRPCAS	International Regulations for the Prevention of Collision at Sea
MOB	Person Overboard
MYC	Manly Yacht Club
NBC	Northern Beaches Council
NOR	Notice of Race
OPTI	Optimist
PFD	Personal Floatation Device
PHS	Performance Handicap System
PRO	Principal Race Officer
RC	Race Committee
RD	Race Director
RO	Race Officer
RRS	Racing Rules of Sailing
RSA	Responsible Service of Alcohol
SC	Sailing Committee
SI	Sailing Instructions
TCF	Time Correction Factor
TfNSW	Transport for NSW
WS	World Sailing

3.2. OTHER SYDNEY CLUBS

BSC	Balmain Sailing Club
CRSC	Concord and Ryde Sailing Club
CYCA	Cruising Yacht Club of Australia (Darling Point)
DSC	Drummoyne Sailing Club
M16SSC	Manly 16ft Skiff Sailing Club
MHSSC	Middle Harbour Skiff Sailing Club (Mosman)
MHYC	Middle Harbour Yacht Club (Mosman)
RANSA	Royal Australian Navy Sailing Association (Darling Point)
RMYC	Royal Motor Yacht Club (Pittwater)
RPAYC	Royal Prince Alfred Yacht Club (Newport)
RPEYC	Royal Prince Edward Yacht Club (Point Piper)
SASC	Sydney Amateur Sailing Club (Cremorne Point)
VYC	Vaucluse Yacht Club (Watsons Bay)
VA12SC	Vaucluse Amateur 12ft Sailing Club

4. MEMBERSHIP AND FACILITIES

4.1. SCHEDULE OF FEES

Crew and skippers of all boats should be members of a yacht club affiliated with Australian Sailing (AS). Temporary membership is available to non-members through the SailPass programme. Non-members may purchase up to 10 SailPasses per annum, after which full club membership fees are payable.

Manly Yacht Club annual memberships are valid from 1st October to 30th September. SailPass fees paid during the membership year will be deducted from the purchase price of an annual MYC membership.

New Adult members joining after 1st March will be offered a \$60 discount on their initial membership.

The MYC membership fee includes a subscription to Australian Sailing including coverage under their Sports Accident Insurance Scheme. This scheme protects sailors and boat owners. All prices include GST.

Membership

Membership	Description	Fees
Adult	Adult membership is available to all members over 18 years of age	\$395
Under 30's	Under 30's membership is available to all members under 30 years of age	\$195
Honorary	Honorary membership is available to non-sailing volunteers who assist with the management of MYC races. Honorary Membership is at the discretion of the MYC Board	\$0
Junior Bundle	Children who are below the age of 18 years and in our Juniors Program – includes membership (\$90), Instructor Fees (\$460), Boat Storage fee (\$145) or Boat Usage fee (\$200)	\$695 or \$750
Student Pricing	Student Pricing Bundle is available for any student under 25 in full time study. Proof of full-time study status is required	\$90
Sailability	Mobility impaired sailors and their volunteer assistants. This includes AS membership.	\$99

Other Fees

ILCA Storage	\$290
MYC Junior Instructor Fees.....	approx. \$30-\$40/day

MYC Tender Service Fees

Self-Drive (excluding Twilights and Race Sundays)	\$1500
Twilights	\$400
Race Sundays	\$300
Full access	\$1900
Twilights plus Race Sundays	\$600



TAHETM

SPORTYAK 245

SUPER STABLE
DURABLE
LIGHTWEIGHT

#EndlessPlayTime
SUP | SUPF | WINDSURF | KAYAK | BOAT

MERCUURY

MADE IN FRANCE

www.tahesport.com

Tahe Outdoors Australia Pty. Ltd | P.O. Box 911 | Manly NSW 1655 | Australia
Ph: 02 9949 1322 | info-aus@taheoutdoors.com

Photo: Pierre Bourlas

4.2. BOAT STORAGE

All boats are stored at MYC in accordance with the following conditions:

- MYC provides boat storage for the following classes and types of boats:
 - O'pen Skiff – mobile racks between building and roadway – 10 boats
 - ILCA 4 & 6– downstairs near roller door to rigging deck – 5 boats
 - ILCA 6 & 7 – 23 boats
- Storage is not available to any other classes or types of boats with the exception of two dragon boats and nine Sailability boats.
- Members will be invited to store boats at MYC on an annual basis. Those not receiving an invitation are required to remove their boats prior to the 1st October.
- The due dates for storage fees are:
 - Juniors and Youth (including ILCA 4 & 6) – Last day of registration period. Note: storage is included in the registration fee.
 - Senior ILCA 6 & 7 – 1st October
- Boat storage is only available to adult or junior members of MYC.
- Juniors and ILCA sailors must actively participate during the current season in 60% of MYC events prior to the Christmas/New Year break and 60% of MYC events after the Christmas/New Year break.
- Only boats used in MYC events can be stored.
- Current Third-Party Liability Insurance must be maintained **by the owner** for all boats stored at MYC,
- Boats are stored at the owner's risk. MYC accepts no responsibility for loss or damage to boats stored at the Club.
- Boats must be stored in locations as directed by the Club Captain. The Club Captain may delegate boat storage arrangements to the appropriate Race Directors to manage their individual storage racks. The Club Captain may change such locations from time to time. For assistance, contact the Club Captain via email at club.captain@myc.org.au.
- All boats, masts, booms, sails and oars etc. must have their boat or owner's name clearly displayed.
- Boats must not be left unattended on the wharf or rigging deck other than in their allocated storage location.
- Oars must not be stored with dinghies and must be stored in the oar racks.
- Fuel must not be stored at MYC (see MYC By-Laws 14).
- Boat owners must advise MYC of their address and contact telephone details and notify MYC in writing of change of address and contact telephone number.
- Failure to comply with these conditions may cause the boat to be removed from MYC. Such removal shall be at the risk of the owner.
- It is the responsibility of the boat owner to ensure that storage and membership fees are paid promptly and on demand.
- If boat storage fees are not paid promptly and on demand the boat and any associated equipment may be sold by MYC and the proceeds of the sale used to meet unpaid fees. Any excess monies may be posted to the boat owner at the last notified address.
- MYC shall not be responsible to maximise the sale proceeds or any loss occasioned by a failure of the boat owner to have notified a correct and up-to-date address.
- The storage fee is not refundable and not transferable.

4.3. MYC COURTESY DINGHIES / TENDER SERVICE

MYC is currently creating a new tender service in conjunction with its courtesy dinghy user group. For details on the rules and use of this group and how to access the service, please refer to the MYC website.

4.4. MYC WHARF AND MOORINGS

The Club wharf, jetty, pontoon and rigging deck, are for the use of Club members and other approved users as per by-law 15. These facilities are not publicly available as demand would far exceed capacity and the Club has neither the insurance nor the maintenance budget to provide such a public facility.

Approved Users

The usage of the Club facilities is extended under by-law 15 to include usage by sub lessees and approved users with the prior permission of the Club Captain. Such approved uses currently include:

- MYC Events (including Yachts, ILCAs Juniors and Sailability) as shown in Section 5.8 MYC Calendar and on the MYC website www.myc.org.au.
- MYC members' private sailing activities.
- Pro Dive for their scheduled pickup and drop-off, of divers.
- Northern Beaches Dragon Boats for storage on the jetty plus their scheduled sessions of warm up on the rigging deck and launch/recover on the pontoon.
- Manly Sailing for their training and charter activities. Charter vessels are requested to display a Manly Sailing logo in some form (e.g. crew shirt).
- Sailing craft visiting from other sailing clubs may use the jetty for casual pickup and drop off. Vessels should be asked to provide prior notice, but reasonable non-habitual usage without notice is acceptable if it does not interfere with other approved activities.
- Small spectator craft used in association with MYC sailing events may use the facilities for casual pickup and drop off, but with the lowest of priorities and no more than 5 minutes alongside.

The Club Captain may at his discretion or by instruction from the Board, blacklist an individual or vessel from using Club facilities and/or revoke approval.

General Usage

- NO FISHING.
- NO RUNNING.
- NO ANIMALS (except disability support animals).
- Casual users must give way to MYC events and approved usages and immediately vacate the facilities. Casual usage must always be attended so that they may immediately comply when asked to move off.
- Unknown users should be cordially asked which club they are from and/or if they are an approved user. Unapproved users should be politely asked to leave and, if they refuse to do so, record their details and report to a club officer. In extreme cases, do not engage in argument but instead call the police.
- Breaches of these rules should be dealt with cordially and calmly. Any disputes should be raised with the Club Captain (club.captain@myc.org.au) for resolution.

Jetty

The jetty is the fixed wooden arm of the wharf extending to the west of the Club, excluding the pontoon and rigging deck but including the fixed and hinged ramp leading to the pontoon.

- Items on the Jetty must not exceed 500 kg in weight.
- Vessels must not hang off nor go along-side the northern edge of the jetty.

Wharf End

The wharf end is the extreme western end of the jetty and is for pick-up and drop off only:

- Vessels must be less than 15m in length and less than 10,000 kg in displacement.
- Vessels at the end of the wharf (other than the Pro Dive boat at scheduled pick-up times) shall move off if other vessels are waiting to pick up or drop off passengers or crew.
- Vessels must not be left unattended when tied up to the wharf end and must be left in a state able to move off at short notice.

Wharf Hold-Off Buoys

The wharf hold-off buoys on the southern side of the jetty are available on a short term, casual basis or with approval of the Club Captain:

- Vessels must be less than 12m in length and less than 8,000 kg in displacement.
- Casual usage is on a first come first served basis and must not be overnight.
- The pontoon may be used to hold off vessels from the jetty, so long as they meet the pontoon usage criteria.

Pontoon

The pontoon is the floating platform. It is for launch, recovery, pickup and drop off, and limited mooring by smaller vessels:

- Vessels going alongside the pontoon must be less than 6m in length and less than 400 kg in displacement. As a guideline, Robbie R should be the largest vessel using the pontoon.
- Vessels that are lifted onto the pontoon must be less than 100 kg in displacement.
- The western and southern sides of the pontoon must be kept clear for launching, pickup and drop off.
- Vessels may be temporarily moored to the eastern side of the pontoon for short periods. Their masters must be in attendance to be able to move off at short notice.
- Vessels may be moored short term by tying off between the pontoon and the jetty on the same basis as the wharf hold-off buoys.
- MYC events have priority over other users of the pontoon.

Rigging Deck

The rigging deck is the wooden platform lying parallel to the western side of the clubhouse. It is for the rigging of smaller sailing vessels and the preparation of tenders and support boats:

- Vessels must be less than 400 kg in displacement.
- Rigging deck users must allow access to the boat storage doors.
- Passage along the rigging deck should not be blocked and clearways maintained.

Jumping, Diving or Swimming from MYC

There are dangers associated with jumping from the wharf and pontoon into the Harbour. Harbour divers or jumpers may encounter debris, boats or other swimmers when entering the water and this could result in injury. To avoid or reduce the chance of injury, the Club has restrictions on jumping and diving from its wharf. The following should be noted by those wanting to jump, dive or swim:

- These restrictions apply to members (both adults and juniors), visitors and the general public.
- Jumping and diving is prohibited from the wharf in all circumstances for all age groups, other than from the pontoon under the following conditions:
 - Adults over 16 providing there are no powered boats in the vicinity.
 - Children under 16 years:
 - Providing there are no powered boats in the vicinity,
 - They have their parent's permission, and
 - They are supervised by their parents or instructors.

MYC takes no responsibility for any injuries that occur when jumping, diving or swimming from its facilities.

Toilets and Showers

The toilets and showers at the Club are available to approved users as follows:

- The upstairs toilets are always available for approved users. Users are asked to give consideration if a function is underway to minimise any disruption.
- The downstairs shower is always available for approved users.
- The downstairs accessible toilet and shower are for use by Sailability, members with disabilities, in emergencies and with prior approval.

Moorings

MYC has a number of moorings allocated to Club members at a reasonable fee or other usage with the prior approval of the Club Manager. Priority may be given to boats that participate in racing. Contact the office for more details and to be advised of availability and waiting list status.

4.5. MYC SUPPORT BOATS

The MYC support boats include the MYC committee vessel, Robbie R, and RIBs (Nigel Holman, Christabel and Margo) and other boats as acquired from time to time.

- The MYC support boats can only be used for MYC activities, or, with the permission of two Sailing Committee members, at least one being a flag officer. All support boat skippers must be authorised by the Club Captain and must have the following qualifications:
 - Completed the MYC online course on how to operate MYC support boats.
 - If using the rigging deck davit crane, must be an authorised user, have completed the MYC davit training course and comply with the Davit Operating Procedures.
 - Provided their Transport for NSW boat licence number and expiry date.
 - Provided their AS number.
- MYC support boats other than the RIBs should be operated by a skipper and an assistant.
- All assistants are required to complete the MYC online course on how to operate MYC support boats.
- Skippers are reminded that they are responsible for checking that all required safety gear is on board, and that passengers remain inside the boat at all times (no bow riding).

4.6. MYC BBQ DECK and BAR

The MYC BBQ deck and bar area are open for our members after each Friday Twilight, Sunday race and some selected Saturdays. With the exception of Twilights, the bar is run on a volunteer basis. Everyone's help is appreciated with setting up the deck; help in the kitchen; and with clearing up at the end of the day.

MYC has a limited licence which permits the sale of alcohol to members and their guests on race days and other nominated events only. No alcohol can be served by any member, unless the member serving has a current RSA certification which is on file at the Club, and who has been approved by the MYC Licensee.

On Sunday race days it is intended that at least one yacht entered in the series will be rostered on for BBQ duty after the race. The crew should come to the Club as soon as possible after completing the race to cook the BBQ and help clean up. All competitors are asked to assist with set up and with cleaning up after the presentation by putting chairs and tables away.

Members may use the BBQ deck at other times for private gatherings of no more than 10 people if it has not been booked for other usage, and with prior confirmation from the venue hire manager.

4.7. WORKING BEES

As a primarily volunteer club, the efforts of the members are required to maintain much of the Club's facilities and assets. Several working bees are scheduled in Section 5.8 MYC Calendar and are coordinated by the Club Captain for lower deck activity and the Club Manager for upper deck activities. It is much appreciated if members can attend and give notice to the Club Captain or Club Manager.

4.8. TRAINING

MYC encourages its members to participate in training activities to help them improve their knowledge and skills as an individual and as part of a team.

MYC Training

Training is offered through online and evening courses (normally on the 2nd Tuesday of each month) for a nominal fee. Subjects covered include:

Racing Rules	It is a requirement of race entry that skipper and / or crew are trained in the Racing Rules of Sailing.
Tactics and Trim	Typically delivered from an elite level sailor provided by Australian Sailing, these sessions will help improve your racing.
Race Management	This course is included to help MYC members who are unfamiliar with the processes involved and is recommended to all members to assist in conducting a race at MYC.
Support Boat	This online course shows members how to operate the MYC support boats, including the MYC committee vessel, Robbie R and the RIBs. This complements the online powerboat users' course that must be completed by all users of MYC support boats. Requirements for use of the MYC support boats are listed in Section 4.5 MYC Support Boats.
Other Topics	Other training topics are offered on demand. Please contact training@myc.org.au to request any specific topic.

Manly Sailing Courses

Manly Sailing introductory course – the AS Keelboat Crew Course – is perfect for learning all the basics of sailing. This course is ideal for the absolute beginner.

Manly Sailing also offers more advanced courses, AS Helming and IYT crew and bareboat skipper courses as well as Term Time Sailing Programs and School Holiday Sailing Camps for children between the ages of 7 and 16 years.

Visit www.manlysailing.com or call 02 9977 4000 or email info@manlysailing.com.au

External Training

There are many external courses that are of value to the racing and cruising sailor as well as Club volunteers. If sufficient numbers are interested in any particular training course, it is possible to organise in house training.

In particular, the Club encourages members to consider training in:

- Sea Safety and Survival
- First Aid
- Radio Operator Certificate of Proficiency
- Boat Licence

External training courses may be located via:

- Australian Sailing – www.sailingresources.org.au
- Marine Rescue NSW – www.marinerescuensw.com.au
- TAFE NSW – www.tafensw.edu.au

4.9. VENUE HIRE

Manly Yacht Club is the perfect waterfront venue, offering stunning views of Sydney Harbour from our hall and generous sheltered balcony.

The income from venue hire is directed towards running of the club and the upkeep of the building and facilities.

The club's venue is available for hire all year round and is perfect for parties, weddings, corporate meetings and conferences,

Venue hire includes the entrance foyer, hall with bar, covered balcony with breathtaking views, kitchen and toilets.

- Venue capacity - 170 cocktail style or 100 seated in the hall and 60 on the balcony.
- BYO Alcohol - buy your own drinks to stock the bar. Dan Murphy's will deliver to the venue and buy back any unused alcohol.
- Catering - self-cater, use your own caterer or one of the club's recommended caterers.
- Furniture - tables and chairs for 100 people and 5 cocktail bar tables are available.
- Decoration - you can decorate yourself or choose a decorator from our preferred suppliers. Fairy lights are included in the main hall and on the balcony.

For further information, refer to our website venuehire.myc.org.au

Members Venue Hire Offer

- **50% discount off the venue hire fee**
- **Free use of the sound system valued at \$230**

*Must be a member of one year or more. * Valid for private functions.



Contact: 0432 901 125
Email: venuehire@myc.org.au
Website: venuehire.myc.org.au

5. SAILING AT MYC

5.1. RACE FEES

Event	MYC Member		Non Member	
	Series	Casual	Series	Casual
Twilight Series	\$350	\$30	\$450	\$35
Twilight Female Helm	included in Twilight Series fees			
Club Championship (includes Manly Sprint Series)	\$350	\$35	\$425	\$50
Summer Series	\$120	\$30	\$150	\$40
Marathon Series	\$100	\$60	\$110	\$70
Winter Series	\$90	\$20	\$120	\$40
Offshore Series (*)	TBA	TBA	TBA	TBA
Manly Sprints Series	\$80		\$80	
Manly Sprints Day 1	\$50		\$50	
Manly Sprints Day 2	\$50		\$50	
Christmas Race		\$0		\$0
Women's Challenge		\$60		\$60
Sailability Regattas		\$15		\$15
ILCA Season	\$200	\$20	\$240	\$25
Junior and Youth	included in instructor fees			

(*) Berthing fees charged by destination marinas for offshore races, such as the Pittwater Race to RMYC or the Shellharbour Race to Shellharbour Marina, will be charged at cost by MYC.

PLEASE REFER TO MYC TENDER SERVICE FEES in Section 4 Membership and Facilities.

5.2. RACE MANAGEMENT ROSTER

Race management at MYC is conducted by our members who volunteer their time to conduct races.

Members will be asked to assist with race management. This may mean that members have to forgo some races during the season. An effort will be made to recruit Race Committee teams from boats not racing in a particular series. Boats that are unable to race due to race management duty may be awarded average points as per Section 7.21.8 Scoring. Crew are encouraged to book their duty day early to give their skippers adequate notice that a replacement crew may be required. If insufficient volunteers are available, the Race Director may allocate duty to a competing boat as per Section 7.30 Duty Boat.

The race management roster will be posted on the MYC website www.myc.org.au.

The Race Officer for each day will be nominated from members with experience in starting yacht races. All users of the MYC support boats must meet the requirements as listed in Section 4.5 MYC Support Boats. Assistants do not need prior experience, but it would be an advantage to have attended an MYC race management course and powerboat familiarisation course as listed in Section 4.8 Training.

The race management team for the races started on the water consists of five members; the Race Officer and an assistant; the mark laying boat driver and an assistant; and a duty officer based in the MYC office. The Race Officer and assistants start the races from the MYC committee vessel, and the mark laying boat, Robbie R.

The team should arrange to be at the Club 2 hours before the race start. Northern Beaches Council parking permits are available at the Club for the day. A salad sandwich and soft drink are provided for lunch, and a free drink is available after the race. The competitors will be very appreciative of your assistance.

Twilight and Winter Series management teams consist of a Race Officer and two assistants, who keep time/yacht spot as they conduct the race starts and finishes from the MYC triangles. Attendance at a MYC race management course is an advantage. These teams should arrange to be at the Club 1 hour before the first scheduled start time. Lunch or dinner is provided.

Junior race management is managed through the MYC Head Coach.

5.3. YACHTS

Yachts race with MYC on Friday Twilights and Sundays during both summer and winter as shown in Section 5.8 MYC Calendar. Sunday racing is split into several series including the Club Championship, the Summer Series, the Marathon series, the Manly Sprint Series and the Winter Series as well as several special event races and combined clubs racing.

Yacht Equipment Audit

The Equipment Audit Form indicates the requirements for Australian Sailing (AS) Special Regulations Equipment Audit which is a condition of race entry. Please consult and refer to the AS Racing Rules of Sailing (the Blue Book) for full details of requirements. Equipment Audit Forms are available from the MYC Office or from the MYC website www.myc.org.au.

An Inspection day is scheduled as shown in Section 5.8 MYC Calendar and takes place at the MYC wharf, on yachts at their moorings in North Harbour or at other locations by appointment. MYC does not allow self-assessment for Equipment Audit Forms. A fee of \$50 may be levied on boats not checked on the annual inspection day.

1. The equipment audited must conform to the rules as set out in the AS Racing Rules of Sailing.
2. The owner or boat's representative completes the AS Equipment Audit Form by initialling in the appropriate boxes on the forms prior to inspection.
3. The inspections of yachts at North Harbour will cover Categories 4 and 7. Yacht inspections at MYC will only cover Category 7. Inspection categories 1 and 2 are to be booked with the Chief Equipment Auditor prior to the inspection day to ensure that an NEA qualified auditor is available at the appointed time.
4. Yachts should report when ready to be inspected at an inspection station either in person, by phone or VHF channel 72 calling 'Manly Yacht Club Inspectors'. No specific times will be allocated, but the aim is to have all completed by 13:00.
5. All yachts to be audited at North Harbour (other than the berth holders at North Harbour Marina) can embark from Manly Boatshed wharf where the owner or their representative will be picked up by the MYC tender. Should an owner/representative transport themselves to their yacht, they can make contact by VHF radio on channel 72 when ready for audit.
6. All equipment should be laid out so that it may be easily checked with the Equipment Auditor.
7. No Equipment Audit Forms will be signed or approved unless all equipment as required is present, in date and in good condition and working order. Any failures will require an extra audit check before the form is completed.

5.4. ILCAS

The senior ILCA fleet at MYC conducts a series of races through the summer months, consisting of the Club Championships and Micro Regatta – using the yardstick method of scoring – and the Spring and Autumn Handicap series, which include Pursuit (*) , teams, sprints and marathon races, as well as several special event races conducted by other Organising Authorities, as shown in Section 5.8 MYC Calendar.

For further information contact the ILCA Race Director via lasers@myc.org.au.

ILCA Equipment Audit

All competing boats must hold an AS Off the Beach Equipment Audit Form. An Inspection day is scheduled as shown in Section 5.8 MYC Calendar and takes place at the MYC wharf.

5.5. JUNIOR AND YOUTH

Described in detail in Section 6 MYC Junior and Youth. The fleets consist of small and full rig O'pen Skiffs and ICLA 4s & 6s for the youth fleet. Racing and training days are as shown in Section 5.8 MYC Calendar.

5.6. SAILABILITY

Sailability is an International Organisation which gives people of all abilities the opportunity to sail. The philosophy of 'Freedom on the Water' is turned into a reality for people of all ages and with a wide range of abilities.

An established charity, Sailability operates in 19 countries, with 350 branches worldwide, 56 of these in Australia. NSW is very active, with 23 branches, 10 of which are in the Sydney area. The most successful model is the one adopted at Manly, and now copied nationwide, where Sailability is included within all activities of Manly Yacht Club.

The membership at Manly is fairly constant at 100, with 60% volunteers, the rest sailors with disabilities. An additional steady stream of casual sailors and volunteers ensure our regular Sailing Days are extremely active, and all are welcome to give sailing a go.

Sailability is funded by sponsorships, donations and the occasional grant for projects such as the Accessible bathroom, new boats, and fuel for our safety boat. All positions are filled by a dedicated team of volunteers who are the backbone of the Club.

Some of our regular sponsors are Bendigo Community Bank, Freshwater; Manly Boatshed; Cromer Golf Club; Hansa Sailing Systems; Premier Automotive; Balgowlah Masonic Club; Lion's Club of Manly; Northern Beaches Council; the Webb Family; the Baines Family; Lynnette Gould.

Our patron is Michael Regan, State Member for Wakehurst. Volunteers come from all walks of life and are not necessarily sailors. There are many shore-based jobs that need doing, but those who would like to learn to sail or drive the safety boat, get the opportunity to add to their skills.

Those sailors who are keen are encouraged to take part in Regattas. Others just love the feeling of floating around on Manly Cove, being close to nature in a very soothing way.

There is nothing more rewarding for volunteers and carers than helping our sailors achieve a feat they never thought possible, and the benefits are amazing.

Sailing Schedule

Shown in Section 5.8 MYC Calendar (every second Saturday and Wednesday in summer) and one Saturday and one Wednesday a month in winter. We also sail on the last Monday of every month.

Volunteers and Membership

Manly Sailability volunteers are a wonderful team of reliable, caring individuals. Sailing Days are fun, fulfilling and rewarding. If you have a few hours a month to spare, contact Manly Sailability Secretary - Stephen Bush - secretary@manlysailing.com.au - 0413 368 173.

Visit www.manlysailability.com.au and click on training tutorials to check out what we do.

5.7. LEARN TO SAIL

Manly Yacht Club supports Manly Sailing as the approved sailing school for MYC. Manly Sailing offer a range of Adult and Children's courses which are accredited by Australian Sailing and International Yacht Training and provide an excellent start for those who wish to get a crewing position on a racing yacht to progress to their own boat or charter a boat internationally..

Courses are based on Australian Sailing National Keelboat and National Small Boat Schemes. In addition to the learn to sail courses, Manly Sailing offers casual sailing, charters and corporate experiences. Manly Sailing professional staff ensure that its customers have fun and learn in a safe and comfortable environment. For further information contact:

Manly Sailing

Finn Irvine, info@manlysailing.com.au

02 9977 4000

<http://www.manlysailing.com>



MANLY SAILING

Unique & unforgettable experiences



- Champagne Cruises
- Corporate regattas & team building
- Private charters
- Junior & adult learn to sail
- Bareboat Skipper courses
- School Holiday programs

10% discount MYC Members on selected products

www.manlysailing.com | info@manlysailing.com.au | 02 9977 4000

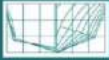

CASTLECRAG MARINE

7 Rockley St, Castlecrag, NSW 2068

Ph 02 9958 0425

info@castlecragmarine.com.au

www.castlecragmarine.com.au

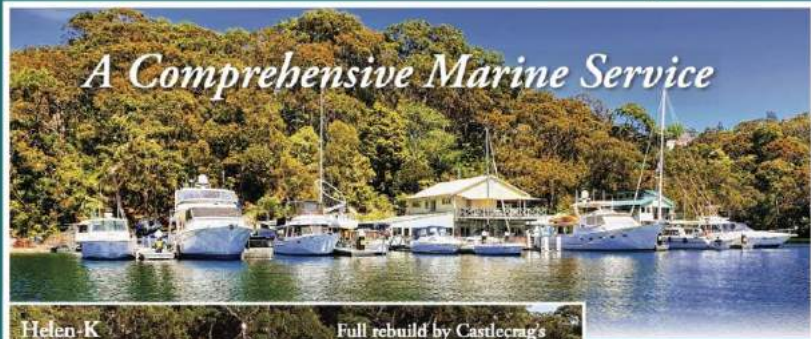

Helen-K
1958 Halvorsen 26' Cruiser

Full rebuild by CastleCrag's
Master Shipwrights



Owner's Testimonial:

Our Halvorsen 26, *Helen-K* had extensive timber rot which ruled out local repairs so we went for a full rebuild from the deck up. Ply and teak cabins with laminated oregon beams. Stayed true to the original shape and dimensions but added a helm door. It was a 12 month job and I can heartily recommend the work of Murray, Stuart and the boys at CastleCrag Marina – excellent workmanship throughout.

- Shipwright
- Paint
- Mechanical
- Vessel Re-Powers
- Electrical
- Rigging
- Fabrication
- Trimming
- Authorised HIN Issuer



A rebuilt deck for Esmerelda



Repowering Ellie



New paint job for Kweena

Brokerage:



COASTWIDE MARINE

coastwidemarine.com.au

CASTLECRAG MARINE

A Comprehensive Marine Service

7 Rockley Street, CastleCrag NSW 2068

Ph: 02 9958 0425

5.8. MYC CALENDAR

	Mon	Tue	Wed	Thu	Fri
	SB	other	SB	other	Yacht
AUG				1	2
2024	5	6 Board	7	8	9
	12	13	14 SB	15	16
	19	20 Safety Briefing	21	22	23
	26 SB	27 SC	28	29	30
SEP	2	3 Board	4	5	6
2024	9	10	11 SB	12	13
	16	17	18	19	20
	23	24 SC	25 SB	26	27
	30 SB	1 Board	2	3	4
OCT	7 OS2	8	9 SB	10	11 TWL1
2024	14	15	16	17	18 TWL2
	21	22	23 SB	24	25 TWL3
	28 SB	29 SC	30	31	1 TWL4/TWF1
NOV	4	5 Melbourne Cup	6 SB	7	8 TWL5
2024	11	12 Board	13	14	15 TWL6
	18	19	20 SB	21	22 TWL7
	25 SB	26 SC	27	28	29 TWL8
DEC	2	3 Board	4 SB	5	6 TWL9/TWF2
2024	9	10	11	12	13 TWL10
	16	17	18 SB	19	20
	23	24 Xmas Eve	25 Xmas Day	26 Boxing Day	27
	30	31 NYE	1 NYD	2	3
JAN	6	7	8	9	10 TWL11/TWF3
2025	13	14	15 SB	16	17 TWL12
	20	21	22	23	24 TWL13
	27 SADR	28 SC	29	30	31 TWL14
FEB	3	4 Board	5 SB	6	7 TWL15
2025	10	11	12	13	14 TWL16/TWF4
	17	18	19 SB	20	21 TWL17

		Sat				Sun			
		SB	Juniors Gold & Silver Fleets	ILCA 4 Fleet	Yacht	Juniors Green Fleet	Yacht	ILCA 6 / ILCA 7	
AUG	3				MHYC Women's Regatta	4			
2024	10	SB				11			
	17				Equipment Audit	18			
	24					25	Race Officer Course - Theory am / Practical pm		
	31				SASC Lion Is Race	1			
SEP	7	Season Opener BBQ				8	CC1 / CCSS1	4P1*/4P2	
2024	14	SB	Season Opener for Parents		CCIS1-RSYS	15	SS1	MR1-4 hosted by MHASC	
	21					22	CC2	CC1/CC2	
	28	SB			CCIS2-MHYC	29	SHWK1-MHYC M1	4P3*/4P4	
OCT	5	NSW Youth Championships Training 1			OS1	6	Training 1	October Long Weekend	
2024	12	SB	Training 2		MHYC Trek	13	Training 2	MSS1-3 / CCSS2-4 Coast Championships	
	19		HPS1/HPS2	CC1/CC2		20	Training 3	CC3 / CCSS5 CC3/CC4	
	26	SB	CC1/CC2	HPS1/HPS2	CCIS3-RPEYC/RSYS	27	Training 4	SHWK2-CYCA SS2 4P5*/4P6	
NOV	2		HPS3/HPS4	CC3/CC4		3	Training 5	CC4 MR5-8 hosted by MYC	
2024	9	SB	Training 3		CCIS4-RSYS/VSC	10	Training 6	SHWK3-RANSA SS3 Battle of the Sound	
	16		Dolphin Chaser	NSW Open & Youth		17	Dolphin Chaser Training 7	CC5 / CCSS6 NSW Open & Youth CC5/CC6	
	23	SB	CC3/CC4	HPS3/HPS4		24	Training 8	SS4 MR9-12 hosted by MYC	
	30		HPS5/HPS6	CC5/CC6	CCIS5-MYC/MHYC	1	Training 9	CC6 4P7*/4P8	
DEC	7	Manly Cup Regatta				8	Manly Cup Regatta		
2024	14	SB	CC5/CC6	HPS5/HPS6	CCIS6-RANSA	15	Adventure Sail	SS5 CC7/CC8	
	21	SBR	Mini Regatta			22	Xmas Race		
	28					29			
JAN	4					5			
2025	11				MHYC Chaos Cup	12	CC7	CC9/CC10	
	18	SB			CCIS7-RANSA	19	SS6	4P9*/4P10	
	25					26	Australia Day		
FEB	1	Training 4			CCIS8-MHYC	2	Training 10	CC8 NSW/ACT State Championships	
2025	8	SB	Kurnell Cup	CC7/CC8		9	Kurnell Cup Training 11	SS7 CC11/CC12	
	15		CC7/CC8	HPS7/HPS8		16	Training 12	MSS4-6 / CCSS7-9 MR13-16 hosted by MHASC	
	22	SB	HPS7/HPS8	CC9/CC10	CCIS9-RSYS	23	Training 13	SHWK4-RSYS M2 Australian Masters	

	Mon	Tue	Wed	Thu	Fri
	SB	other	SB	other	Yacht
	24 SB	25 SC	26	27	28 TWL18
MAR	3	4 Board	5 SB	6	7 TWL19
2025	10	11	12	13	14 TWL20/TWF5
	17	18	19 SB	20	21 TWL21
	24	25 SC	26	27	28
	31 SB / SPS	1 SPS	2 SPS	3 SPS	4 SPS
APR	7	8 Board	9 SB	10	11
2025	14	15	16	17	18 OS3 - Pittwater
	21 Easter	22	23 SB	24	25 Anzac Day
	28 SB	29 SC	30	1	2
MAY	5	6 Board	7 SB	8	9
2025	12	13	14 SVRE	15	16
	19	20	21 SB	22	23
	26 SB	27 SC	28	29	30
JUN	2	3 Board	4	5	6
2025	9 King's Birthday	10	11	12	13
	16	17	18 SB	19	20
	23	24 SC	25	26	27
	30 SB	1 Board	2	3	4
JUL	7	8	9	10	11
2025	14	15	16 SB	17	18
	21	22	23	24	25
	28 SB	29 SC	30	31	

Calendar Legend

- | | | | |
|------|-------------------------------|------|-----------------------------------|
| 4P | 4P Championship | M | Marathon |
| CC | Club Championship | MSS | Manly Sprint Series |
| CCIS | Combined Clubs Inshore Series | OS | Offshore Series |
| CR | Christmas Race | SADR | Sailability Australia Day Regatta |
| CCSS | Combined Clubs Sunday Series | SB | Sailability Sailing Day |
| HPS | Handicap Point Score | SBR | Sailability Regatta |

		Sat				Sun			
		SB	Juniors Gold & Silver Fleets	ILCA 4 Fleet	Yacht	Juniors Green Fleet	Yacht	ILCA 6 / ILCA 7	
MAR	1		Training 5		SHR	2	Training 14	SHR	4P11*/4P12
2025	8	SB	Destination Race			9	Training 15	CC9 / CCSS10	
				Metro Champs					
	15		CC9/CC10	HPS9/HPS10	CCIS10-RPEYC/RSYS	16	Training 16	SS8	CC13/CC14
	22		WC			23	Training 17	SHWKS-MYC WC	
	29		HPS9/HPS10	CC11/CC12		30	Training 18		4P13*/4P14
APR	5		Teams racing		SPS	6	Training 19	SPS	4P15*/4P16
2025	12	SB	End of Summer Social			13	Training 20	CC10 / CCSS11	CC15/CC16
			Force 24 Regatta						
	19		Easter			20	Easter Long Weekend		
	26	SB				27	Anzac Long Weekend		
MAY	3					4			
2025	10	SB				11			
	17					18		WS1	
	24	SBR	Presentation Night			25			
	31					1		WS2	
JUN	7	SB				8			
2025	14					15		WS3	
	21					22			
	28		AGM Social Night			29		WS4	
JUL	5	SB				6			
2025	12					13		WS5	
	19					20			
	26					27		WS6	

SC Sailing Committee
SHWKS Sydney Harbour Women's Keelboat
SHR Sydney Harbour Regatta
SPS Sail Port Stephens
SS Summer Series
SRS Short Race Series

SVRE Sailability Volunteer Recognition Eve
TWL Twilight Series
TWF Twilight Series Female Helm
WC Women's Challenge
WS Winter Series

5.9. TROPHIES AND PRESENTATIONS

Trophies awarded are summarised in the tables below. Perpetual trophies are designated 'P' and individual trophies 'I'. Fleet numbers will determine whether trophies are presented.

TROPHY	SAILABILITY	ILCA	YACHTS DIV 1	YACHTS DIV 2
Club Champion		P	P	P
Spring Point Score		P		
Autumn Point Score		P		
Annual Point Score		P		
4P Championship		P		
Twilight Racing			P	
Marathon			P	P
Manly Sprint Series		P	P	
Women's Challenge	I	I	P	P
Offshore Series			P	
Summer Series			P	
Winter Trophy			P	P
Bob Greene Trophy			P	
Davis Cup				P
Volunteer of the Year	I			
Sailor of the Year	I			
Most Improved Sailor of the Year	I			
David Parle Trophy			P	

The Bob Greene Trophy is awarded to the Division 1 Yacht with the most line honours.

The Davis Cup is awarded to the Division 2 Yacht with the most line honours.

The David Parle Trophy is awarded to the Good Friday Pittwater Race winner on handicap.

There are seven perpetual trophies which may be presented to a sailor or yacht of any class.

TROPHY	AWARD
Nigel Holman Trophy	Outstanding seamanship or on-water achievement
Peter Wilkins Starter's Trophy	Yacht with consistent best starts for season
Graeme Cotton Good Citizen Award	Recognises qualities and values instilled in the Club
Women's Challenge One Design	Winner of one design
Captain Bligh Trophy	"You'll do as you're told" Cat O'Nine Tails
Fletcher Christian Trophy	Cannon of reason, resistance and rebellion
Catering Cup	Recognises qualities and values instilled in the ILCA fleet in the Club

Junior and Youth Classes

TROPHY	O'pen Skiff	ILCA 4	F11s
Club Champion	P	P	P
Handicap Point Score	P	P	P
Mini Regatta	P	P	P
Marathon	P	P	P
Women's Challenge	I	I	I
Capsize Cup	I		
Splash Down Dash	I		
Bruce Davis Manly Cup	P		

There are 2 individual awards which may be presented to a sailor or boat of any class.

TROPHY	AWARD
Instructors Award – Racer	Attendance tally and points awarded every sailing day for attitude, application and improvement.
Instructors Award – Novice	

PETER WILKINS STARTER'S PRIZE

**CLOSEST TO ALLOCATED START TIME
TWILIGHTS, SUMMER AND MARATHON SERIES**

5.10. MYC YACHT REGISTRY

SAIL #	BOAT NAME	CLASS	OWNER(S)
MYC3	Madama Butterfly	S80	Mike Share
MYC6	My Girl	Cavalier 26	Gordon Ian Coates
MYC7	Ten Sixty	Radford 10.6	Mark Stacey / Bob Day / Albert James / Barry Henderson
MYC8	Crux	S&S 34	Carlos Aydos
MYC10	Pensive	NSX 38	Pam Davis
MYC12	San Toy	Radford 12	Graham / Maz Radford
MYC21	Opal Leaf	Elan GT6	John Eager
MYC 24	Phantom Menace	Phantom 32	Ben Sheridan / Matt McLellan
MYC27	Esra Tew	North Shore 27	Mark Bode / Jackie Morgan
MYC32	Esprit	Archambault 32	Greg Wilkins / Jan Bartel
MYC37	Moonraker	Beneteau Oceanis 37	Tomas Kliman / Muir Watson
MYC38	Manu	Leonard Eagle 38	Steve Chiodo
MYC79	Pompadi	Catalina 309	Steve Frith / John O'Brien
MYC99	Jupiter	J99	Ian Smith
MYC100	Shear Magic	Adams 10	Michael Evans / Stephen Smith
MYC122	Joss	J122	Pam Davis
MYC157	Lady Canasta	Catalina 380	Edward van Oort-Pieck
MYC320	Calypso	Elan S3	Xavier Decomps
MYC409	Solace	Jeanneau Sun Odyssey 409	Xavier Decomps

Please contact the MYC Office to obtain an MYC sail number.

5.11. YACHT SPOTTERS GUIDE

SAIL #	BOAT NAME	CLASS	OWNER(S)
AUS4801	Ace	J24	David West
R350	Absolut	Archambault 34	Phil Vidler / David Ashton / Ian Green
2407	<i>Aqualuna racing</i> as Manly Sailing Aqualuna	Force 24	Finn Irvine
1152	Bokarra	Santana 22	Colin / Iain Cameron
7232	Ça Va	Jeanneau Sun Odyssey 440	Phil Dressler
5830	Cheap Thrills	Ross 830	Barry Mifflin
26996	Daybreak	Palmer Johnson New York 40	Kimbyl / Karen Mann
7147	Escape	Beneteau Oceanis 41.1	Dean Dransfield
3760	Emerald	Cavalier 28	Brad Van Dijk / Karrie Rose
GBR579 OR	Enigma	Beneteau First 47.7	Jason Bond
024	<i>Equinox racing</i> as Manly Sailing Equinox	Force 24	Finn Irvine
MH382	Esprit de Four	Dufour 382	Paul McCarthy / Jeremy Goddard / Mike Abbott
7778	Farr N Away	Beneteau First 40.7	Rosie Lee
338	Fast Company	Young 88	Graeme Gaggin
MR24	Flakey Mojo	Marauder 24	Deanna Smyth
RQ71	Gecko	Northshore 370	Glenn Paterson
4713	Gumeracha	S&S Defiance 30	Duncan Stirling
AUS1129	Jabberwocky	J70	Andrew Tompson
AUS4770	Kaotic	J24	Arthur Crothers
7709	Kanreki	Cookson 12	Michael Rowe / Ben Martin
6153	Kia Kaha	Young 88	Andrew Watt/Julian McPherson
35002	Khaleesi	1D35	Bryan/Peter Grayson
1620	Kryptonite	Catalina 34 Mk II	David Wright / John Bussey
1919	Lost Horizon	Archambault 32	Brett Hudson
6448	Ludicrous Mode	Hick 31	Bevan McKavanagh / Scott Breakwell / Stuart Smith
3829	Magician V	Swarbrick 9.9	Grant Windsham
1255	Melody	Swanson Dart	Marike Koppenol
4861	Micron	Cavalier 30	Stuart Snell
6479	Misky	Northshore 340	Peter Bennell
5656	Mondo	Sydney 38 OD	Lisa Callaghan / Stephen Teudt / Nadine McBain
AUS4436	Okavango Delta	J24	Lyn Humphreys / Will Hough / Macie Bourke / Charlie Snell / Ollie Ross
KA16	Pam	International 5.5	Al Sims / Matt Walker / Peter McDonald

YC868	Velocity racing as Peach Teats-Velocity	Beneteau First 31.7	Peter Walker
6295	Ratty Tooley	Northshore 340	Ian Dennewald
7178	Ruffiana	Beneteau Oceanis 38	Neil Hardiman/Jono Rogers
7888	Sakana	Beneteau Oceanis 41.1	Stephen Coleman
46075	Savannah Girl	Swan 46	Nicholas Robson
MH118	Sirius	Adams 10	Garth Riley
AUS144	Stock Car	J24	Kenneth Tuckey
2776	Supernova racing as Manly Sailing Supernova	Force 24	Finn Irvine
EAU868	Total Nuisance	Etchells	Stephen Leslie
4434	Waterhound	J24	Anthony Poole

5.12. ILCA SPOTTERS GUIDE

SAIL #	BOAT NAME	CLASS	OWNER
121 000	Bruce	ILCA7	Sam Jackson
141 936	Chance	ILCA7	Mike Franklin
163 885	Neodymium	ILCA7	Andy Padgett
166 818	Tom Yum	ILCA7	David Holland
168 137	Cheeky	ILCA7	Shaun O'Reilly
173 435	Fragile	ILCA7	Gordon Lacey
176 158	Deluge	ILCA6	Tim Docker
184 668	Tequila	ILCA7	Cameron Wall
185 400	El Volador	ILCA7	Lloyd Harrison
192 270	Iolani	ILCA7	Iain Cameron
193 407	Blue	ILCA6	Ali Devlin
197266	Shark Bait	ILCA7	Geoff Gill
202 883	Bád	ILCA6	Phil Reid
202 883	202883	ILCA6	Seamus Smart
205 751	Salty	ILCA6	Evie Saunders
208 881	Newman	ILCA7	David Walton
210 201	2cheeks	ILCA7	Garth Riley
212 887	Kramer	ILCA7	Richard Lacey
215 011	Send it!	ILCA7	Ian Saunders

5.13. SAILABILITY SPOTTERS GUIDE

SAIL #	BOAT NAME	CLASS	SAIL COLOUR
151	Clea	2.3 Hansa Double	Yellow and Green
185	Alan Wood	2.3 Hansa Single servo	White with Red Stripe
753	Dolly Wallis	303 Hansa Double	Purple
833	Woody	303 Hansa Double	Pink
1598	Ralph Newman	303 Hansa Double	Orange
1662	Alex	303 Hansa Double	Green
2232	Vin	303 Hansa Double	Red
2238	Black Swan	303 Hansa Double	Fluoro
2419	Eli D	303 Hansa Double	Light Blue

5.14. MYC OWNED JUNIOR FLEET

- 3 Flying 11s
- 10 O'pen Skiffs
- 10 Small Rig O'pen Skiffs, and
- 10 Optimists

OSM

One Stop Marine

MARINE SPECIALIST SERVICES

*BOAT REPAIRS

*BOAT MANAGEMENT

*ANTI FOULING

*RUNNING RIGGING

*CREW TRAINING

*DETAILING

*SPLICING

*DOCK LINES

CONTACT **MITCH WHITE**

📞 0405 000 210

mitch@onestopmarine.com.au
www.onestopmarine.com.au









5.15. RISK WARNING

This RISK WARNING is issued jointly by Manly Yacht Club and Transport for NSW, pursuant to the Civil Liberty Act 2002 to all persons wishing to participate in the sailing activities conducted by Manly Yacht Club.

Participants are warned that, regardless of the precautions which might be taken by reasonable and experienced persons, sailing can be a dangerous pursuit and participants are exposed to significant risk of property damage, physical harm and possible death.

As an indication, these risks may include, but are not limited to:

- The extremes of weather and sea conditions.
- The potential that control of vessels may be lost, resulting in collision with objects and other vessels.
- The sudden movement of the vessel at any time and the possibility that participants may fall or be thrown overboard, resulting in drowning.
- The possibility that participants may be injured by equipment on the vessel.
- The absence of immediate medical care and the likelihood that significant delays may occur before medical care is available.
- Exposure to the elements for extended periods.

Manly Yacht Club and Transport for NSW also warn participants that regardless of their best intentions, they may be unable to render assistance to participants who are in distress.

Manly Yacht Club reminds participants that when sailing, really serious injuries of the type that can cause permanent disablement or even death are statistically very rare but can and do occur. As with any water sport, the possibility of drowning is also present. While for many sailing activities a support boat might be present, the boat cannot be everywhere at once, cannot observe every incident that occurs and may not always recognise an observed incident as being a serious one requiring immediate response. First aid or medical assistance is not always available.

Manly Yacht Club further reminds participants and visitors to be cognisant of slip, trip, cut and moving object hazards in Manly Yacht Club environs, including buildings, storage areas, rigging deck, jetty, pontoon and launching ramps.

Participants are warned to consider the above risks and all other risks before deciding to participate in any sailing event with Manly Yacht Club.

Note Well

Participants are advised that although Manly Yacht Club is covered by third party liability insurance, **this cover DOES NOT extend to participants.**

A personal accident insurance policy is provided with membership of Australian Sailing (AS). Membership of MYC includes membership to Australian Sailing. It is a requirement of race entry that all crew with more than 3 races in Australia have Australian Sailing or similar membership.

5.16. RISK ASSESSMENT

RISK	LIKELIHOOD	CONSEQUENCE	INHERENT RISK LEVEL
Dinghy Capsize	Likely	Major	High
Person Overboard	Possible	Major	Moderate
Injury to crew	Possible	Moderate	Moderate
Vessel Damage	Possible	Moderate	Moderate
Vessel Grounding	Possible	Moderate	Moderate
Vessel Sinking	Unlikely	Catastrophic	Moderate
Vessel Fire	Rare	Catastrophic	Moderate
Bad Weather	Almost Certain	Minor	Low
Collision	Possible	Minor	Low

Risk Controls

RISK	RISK CONTROL	WHO	RESIDUAL RISK LEVEL
Dinghy Capsize	<ul style="list-style-type: none"> • Training for capsize self-recovery. • Training for supported capsize recovery. • Training for exclusion zones around ferries. • Maintain a low ratio of juniors to support boats. • Support boat render assistance. • Support boat reassess conditions and crew fatigue and may suspend racing. • Support boat may tow capsized vessel out of path of ferry and commercial vessels. 	Skipper, Support boat	Low
Person Overboard (MOB)	<ul style="list-style-type: none"> • Annual vessel Equipment Audit includes lifelines; life rings; PFDs; throw lines and other AS-mandated safety devices. • Racing is conducted within VHF and mobile phone range of emergency services. • Duty Officer monitors race frequency and Club phone during inshore races. • MYC Section 5.17 Safety Plan for Competitors includes procedures for MOB. 	Skipper	Low
Collision	<ul style="list-style-type: none"> • MYC provides regular training and briefings on the Racing Rules of Sailing. • MYC requires an annual skipper declaration of understanding of the Racing Rules of Sailing and 'COLREGS'. • Vessels are required to keep constant lookout. • MYC Section 5.17 Safety Plan for Competitors includes procedures for collision. 	Skipper	Low

RISK	RISK CONTROL	WHO	RESIDUAL RISK LEVEL
Injury to Crew	<ul style="list-style-type: none"> • Vessel Equipment Audit includes first aid kit. • MYC facilitates attendance of first aid training. • MYC Section 5.17 Safety Plan for Competitors includes procedures for injury. 	Skipper	Low
Vessel Damage (e.g. dismasting)	<ul style="list-style-type: none"> • Annual vessel Equipment Audit includes PFDs, fire extinguishers, hull plugs, anchors and other safety equipment mandated by AS. • Racing is conducted within VHF and mobile phone range of emergency services. • MYC Section 5.17 Safety Plan for Competitors includes procedures for damage, sinking, fire and grounding. 	Skipper	Low
Vessel Grounding			Low
Vessel Sinking			Low
Vessel Fire			Low
Bad Weather	<ul style="list-style-type: none"> • Annual vessel Equipment Audit includes suitable sails and safety equipment for each category of racing as determined by AS. • Racing is conducted substantially within a range of weather forecasts available via radio, VHF and/or mobile coverage. • Race committee given authority and guidance to abandon racing for observed and/or forecast bad weather (see Section 5.20 Strong Wind Abandonment Guidelines). • Race Committee monitors weather observations and forecasts. • Offshore races are preceded by a skipper's briefing. • MYC Section 5.17 Safety Plan for Competitors includes procedures for Bad Weather. 	Race Officer, Skipper	Low
Collision	<ul style="list-style-type: none"> • MYC provides regular training and briefings on the Racing Rules of Sailing. • MYC requires an annual skipper declaration of understanding of the Racing Rules of Sailing and 'COLREGS'. • Vessels are required to keep constant lookout. • MYC Section 5.17 Safety Plan for Competitors includes procedures for collision. • Support boat may escort juniors over ferry route. 	Skipper	Low

5.17. SAFETY PLAN FOR COMPETITORS

Before Racing

The skipper of each boat is responsible for ensuring that the boat is properly prepared and that all crew are adequately briefed or trained. The Skipper shall:

- Ensure that the boat's insurance and Safety Equipment Audit Form is current and appropriate for the race category.
- Ensure that all safety equipment is on board and in good working condition.
- Ensure that the crew knows where the safety equipment is stowed and how to use it.
- Ensure that the crew is briefed on the boat's safety plans in the event of an incident, including all roles and procedures to be followed.
- Ensure all crew is competent in the boat's Person Overboard procedures.
- Ensure that appropriately competent and experienced crew is on board to cope with the conditions likely to be experienced.

On the Water Safety Plan

RISK	SAFETY PLAN
Dinghy Capsize	<ul style="list-style-type: none"> • Support boat re-assess conditions and crew fatigue and may suspend racing. • Support boat may tow capsized vessel out of path of ferry and commercial vessels.
Person Overboard (MOB)	<ul style="list-style-type: none"> • Suspend racing. • Commence Person Overboard (MOB) procedure. • Record exact location. • Contact emergency services if required, via a VHF call to Marine Rescue and/or phone 000 (see Section 5.18 Emergency Communications). • Request assistance from other boats if needed with a MAYDAY VHF 16 call or DSC signal (see Section 5.18 Emergency Communications). • If MOB on another vessel, render assistance if required. • File an incident report to MYC and/or TfNSW (see Section 5.19 Incident Reporting).
Injury to Crew	<ul style="list-style-type: none"> • Suspend racing. • Commence first aid. • Contact emergency services if required, via a VHF call to Marine Rescue and/or phone 000 (see Section 5.18 Emergency Communications). • Contact Race Committee if required: for assistance; relay to emergency services; and/ or withdrawing from race. • Follow directions of emergency services to evacuation location. • File an incident report to MYC and/or TfNSW (see Section 5.19 Incident Reporting).
Vessel Damage (e.g. dismasting)	<ul style="list-style-type: none"> • Suspend racing. • Instruct crew to wear PFDs.
Vessel Grounding	<ul style="list-style-type: none"> • Assess damage and begin any possible remediation.
Vessel Sinking	

RISK	SAFETY PLAN
Vessel Fire	<ul style="list-style-type: none"> • Request assistance from other boats if needed with a PAN PAN or MAYDAY VHF call or DSC signal. • Contact emergency services if required via a VHF call to Marine Rescue and/or phone 000 (see Section 5.18 Emergency Communication). • Contact Race Committee if required for: assistance; communication with emergency services; and/or withdrawing from race. • Deploy anchor and other safety devices if appropriate. • If damage to another vessel, suspend racing and render assistance as required and reasonable. • File an incident report to MYC and/or TfNSW (see Section 5.19 Incident Reporting).
Bad Weather	<ul style="list-style-type: none"> • Assess current observed weather and forecast with consideration for crew experience and safety equipment available (see Section 5.20 Strong Wind Abandonment Guidelines). • Instruct crew to wear PFD and harnesses (if available). • Shorten sails in anticipation or drop sails and start motor. • Deploy anchor and/or other safety devices if appropriate. • Contact Race Committee if required: for assistance; communication with emergency services; and/ or withdrawing from race.
Collision	<ul style="list-style-type: none"> • Assess damage/injury and if significant proceed as for Vessel Damage and/or Injury to Crew. • Assess damage/injury to other vessel and if significant stand by to provide assistance if required and reasonable. • Record time and identity of the other vessel. • Contact emergency services if required, via a VHF call to Marine Rescue and/or phone 000 (see Section 5.18 Emergency Communication). • Contact Race Committee if required: for assistance; relay to emergency services; and/ or withdrawing from race. • Follow race protest procedures. • File an incident report to MYC and/or TfNSW (see Section 5.19 Incident Reporting).

5.18. EMERGENCY COMMUNICATIONS

When a vessel requires Emergency Response, the vessel should use the standard marine emergency call procedures (MAYDAY or PAN PAN).

- MAYDAY on VHF Channel 16 – Only used if a vessel or person is in grave and imminent danger and requires immediate assistance. If possible, also dial '000'.
- PAN PAN on VHF Channel 16 – Used when a MAYDAY distress signal is not fully justified – vessel requires assistance but is not in grave or imminent danger, or if an urgent safety message concerning safety of the vessel or person. If possible, also dial '000'.

If Radio is equipped with DSC, trigger an emergency signal. Use the appropriate DSC code if possible.

If the incident does not merit a MAYDAY or PAN PAN call but emergency assistance is required in NSW waters, call the NSW Water Police (000) as the primary Agency responsible for coordinating Emergency Response.

Dial 000 to contact Ambulance, Police and/or the Water Police. Stay calm and answer all the questions asked by the operator to the best of your ability.

Use VHF Ch16 rather than VHF Ch72 for contacting Marine Rescue, then follow their instructions regarding a frequency. Competitors should be in the habit of using dual watch to monitor both VHF Ch16 and Ch72 during a race.

During and after an incident, the chain of command for Club operations follows the Race Committee structures. RC members report to the Race Officer, who reports to the Principle Race Officer who reports to the Commodore.

For a major incident, only the Commodore and President are authorised to speak to the media regarding the incident.

Members should carefully consider any postings to social media that may spread incorrect information and/or undue concern.

5.19. INCIDENT REPORTING

Fines can be imposed by TfNSW if major incidents are not reported and it is a requirement of the Club's Aquatic Licence that it logs minor incidents reports. A Vessel Incident Form and links are available on the MYC website www.myc.org.au and from TfNSW.

TfNSW allows minor incidents to be reported and recorded by the Club, but any on water incident that involves injury or significant damage must be reported to TfNSW and the Club.

Personal Injury during a race

- Skipper or delegate calls Ambulance (000) or Marine Rescue (VHF Ch16) if necessary.
- Skipper or delegate calls Duty Officer (VHF Ch72 or phone 9977 4949) who can arrange Ambulance if needed (description of injury required). Take all other action necessary as prescribed in MYC Section 5.17 Safety Plan for Competitors in the MYC Handbook.
- Duty Officer will inform Race Director and draft MYC Accident/Incident report.
- After race, Skipper or delegate checks the MYC Accident/Incident Report details and authorises as correct (as it may be used as evidence).
- Skipper or delegate, as soon as practicable, completes the TfNSW incident report form.
- Send a copy of the TfNSW Incident Report to the Club (info@myc.org.au).

Personal Injury on MYC property (non-racing)

- Ambulance is called if necessary. If deemed not necessary, hospital (emergency) visit is to be recommended – particularly if injured is underage.
- A member of the Club who has witnessed an incident or has knowledge of such an incident must notify the Club Manager or Hall Hire Manager or Club Captain or President immediately – contacts are found in Section 1 Contact Details of the MYC Handbook.
- Either will write up the MYC Accident/Incident report and later have the reporting member check the details and authorise the MYC Accident/Incident Report as correct (as it may be used as evidence).

Property damage (no injury) during a race

- Skipper or delegate calls Duty Officer (VHF Ch72 or phone 9977 4949).
- Take all action necessary as prescribed in MYC Section 5.17 Safety Plan for Competitors in the MYC Handbook.
- Duty Officer will write up Accident/Incident report. Duty Officer will inform Race Director and later have the Skipper or delegate check the details and authorise the MYC Accident/Incident Report as correct.
- If the damage is significant, Skipper or delegate, as soon as practicable, completes the TfNSW incident report form.
- Send a copy of the TfNSW Incident Report to the Club (info@myc.org.au).

Property damage on MYC property (non-racing)

- Photograph if you can and call the Police if damage is still being caused (000).
- A member of the Club who has witnessed an incident or has knowledge of such an incident must notify the Club Manager or Hall Hire Manager or Club Captain or President immediately. Contacts can be found in Section 1 Contact Details of the MYC Handbook.
- An MYC Accident/Incident report will be written and, as soon as practicable, have the reporting member check the details and authorise the MYC Incident report as correct.

5.20. STRONG WIND ABANDONMENT GUIDELINES

The information below is a set of guidelines and information to help make a judgement as to whether to start a race or not.

Races should not be started if in the opinion of the Race Committee the maximum wind gust average over 3 seconds exceeds one of the values below:

- 20kt for Junior and ILCA 4 race fleets
- 25kt for ILCA 6 & 7
- 28kt for Yachts

The Race Committee must always check the specific Sailing Instructions rather than rely on any limits quoted here or assumed from previous experience.

The 3 second average is used by the Bureau of Meteorology (BOM) observations when reporting gusts. See <http://www.bom.gov.au/catalogue/observations/about-weather-observations.shtml>.

The BOM warns that wind gusts can be 40 percent higher than average wind speeds, so 14kt average wind speed can produce 20kt gusts, 18kt average can produce 25kt gusts and 22kt average can produce 30kt gusts.

When considering abandonment, the Race Committee should consult the BOM weather warnings at <http://www.bom.gov.au/nsw/warnings/marinewind.shtml>.

If on the morning of the race there is a Gale Warning (34 to 47 knots) for the racing area typically Sydney Closed Waters, then the decision will be to abandon.

With a Strong Wind Warning (26 to 33 knots), then the decisions will mostly be to abandon if their indications are that the forecast is accurate.

If there is no Gale Warning, then the expected wind speeds can be obtained from the BOM forecasts at <http://www.bom.gov.au/forecasts/graphical/marine/nsw/sydney.php>.

A race should seldom be abandoned purely on the basis of a forecast; rather the forecast should be used to better interpret the observations of the day. For example, if there are stronger winds predicted after the race or geographically close to the race, then additional caution should be used as weather may arrive early or change location.

Should you believe the wind may ease in the near future, for example because at the time of the scheduled start a front was moving through the race area, you don't necessarily have to abandon the day's racing. You can postpone the start of the race until conditions moderate by using the AP flag. This should also be communicated on VHF 72 to the competitors.

AP



With 2 sound signals



The ultimate authority when judging abandonment is the observations of actual average wind speed and gusts obtained either from the BOM (<http://www.bom.gov.au/nsw/observations/coastal.shtml>) or from instruments on the committee vessel (or similar). As well as local observations, more distant observations up and down the coast can be used to make a judgement about accuracy or otherwise of the forecast and to see what weather is coming.

While it is considerate to abandon races early (especially for boats coming through the Spit Bridge), the Race Committee should make reasonable effort to hold a race. Conversely, just because a race has not been abandoned before contestants have arrived at the course is not a reason to not abandon. Safety is the only consideration and a race may be abandoned even after the start if the conditions deteriorate.

The Race Committee can discuss the conditions and forecast with the Race Director, Principal Race Officer, Commodore or any other experienced sailors. Race Directors should ensure that Race Committees have the correct details at hand. **Please be aware that the Race Officer is responsible for the decision. The Race Officer can take advice but not direction from others.**

If MYC abandons a race, it is typically for the remainder of the day, so the N flag should be flown over the A flag and 3 sound signals made. There are large N and A flags in the office. Abandonment should also be communicated over VHF and/or by SMS.

N over A



With 3 sound signals



[Book a Demo](#) | 9451 0901 | orderxpress.com.au | Unit 14 Bldg 7/49 Frenchs Forest Rd E, Frenchs Forest NSW 2086

5.21. DECK, BOATS AND ACTION PLAN

SATURDAY:

Here is when to rig and launch; and when to retrieve and unrig.

Deck, Boats and Action Plan 2024-2025 (Plan A)																								
SATURDAY																								
Day																								
Hour	8	9	10	11	12	1	2	3	4															
Minute	00	10	20	30	40	50	00	10	20	30	40	50	00	10	20	30	40	50	00	10	20	30	40	50
Rigging Deck and pontoon	Manly Sailing Launch	Sailability Launch	Retrieve	Manly Sailing	Retrieve	Sailability	Gold Fleet Launch	EWS	Gold Fleet	Retrieve	Silver Fleet Launch	EWS	ILCA Fleet Launch	EWS	ILCA Fleet	Retrieve	Gold Fleet	Retrieve	Silver Fleet	ILCA Fleet	Retrieve			
Robbie R	Manly Sailing												Gold, Silver and ILCA Fleets											
Nigel Holman													Gold, Silver and ILCA Fleets											
Margo	Manly Sailing												Silver Fleet											
Christabel													Gold and ILCA Fleets											
Ready Get Set													Gold, Silver and ILCA Fleets											

SAILING AT MYC

Here is a handy summary of the Deck, Boats and Action Plan that can be used by all stakeholders.

Deck, Boats and Action Plan Summary 2024-2025 (Plan A)								
	Saturday					Sunday		
Deck Available	Manly Sailing	Sailability	Silver Fleet	Gold Fleet	ILCA Fleet	Manly Sailing	Green Fleet	ILCA Fleet
Deck Captain Arrives								
Sailor Briefing			12:50	12:50	12:50		12:30	
Deck Available	8:00	8:30	1:00	1:00	1:10	8:00	12:30	1:00
Coach/Support Boat Briefing			1:10				12:40	
Fleet Launch	9:00	9:20	1:40	1:40	2:00	9:00	1:10	1:30
Earliest possible warning			2:20	2:20	2:30			2:00
Fleet Retrieval: all hands-on deck	10:30	11:40	~3:50	~3:50	~4:00	10:30	~3:00	3:20
De-Briefing			4:30	4:30	4:30		3:30	
All boats on deck ready for next user	11:30					11:30		
All boats washed and put away		1:00	5:30	5:30	5:30		4:00	5:00
Lock-up, Deck Captain departs					5:35			

Note:

Users can access the rigging deck and pontoon outside their designated times but must give way to those rigging / unrigging during their designated time.

Legend for Saturday and Sunday Deck usage.

Gold, Silver, Green Fleet	O'pen Skiff sailing dinghy
ILCA Saturday	ILCA 4 sailing dinghy with a 4.7 m sail
ILCA Sunday	ILCA 7 sailing dinghy with full sail, ILCA 6 sailing dinghy with radial sail and ILCA 4 sailing dinghy with 4.7 sail
EWS	Earliest Warning Signal
Manly Sailing	Manly Sailing
Sailability	Sailability Manly

Note; The committee vessel and/or the Robbie R may be unavailable for Manly Sailing or Juniors use on Sydney Harbour Regatta, Women's Challenge, yacht Marathons and the Manly Sprint Series. Sufficient notice will be given to affected stakeholders when these, and possibly other occasions occur, Rigging and Equipment plans will be issued for these events.

5.22. DECK RIGGING PLAN

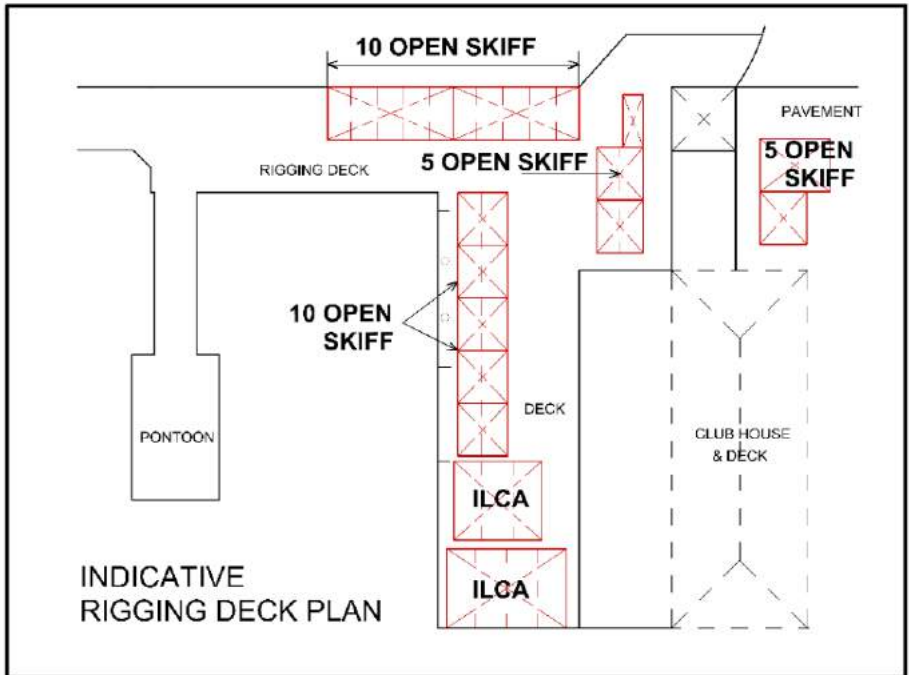

5.23. ON WATER MANAGEMENT

On a typical Saturday we can expect up to 44 boats on the water while on Sundays with the yachts sailing, we could have over 60 boats and 140 people. Usually the racing fleets are managed by the Race Officers or by the most senior instructor. Under normal conditions we have more than enough support boats to manage the fleets and they can operate independently. However, on some occasions breakdowns or weather may intervene and require a redeployment of resources. It should be noted that redeployment may need to happen between the junior, ILCA and yacht fleets.

In these rare circumstances experience has shown that it is best to have a central command to meet the needs of all of our sailors. If a Race Committee is in attendance, then the Race Officer will take responsibility for all on water management. If a Race Committee is not present, then the most senior instructor will take over the on-water management role. The on-water manager may vary the Deck, Boats and Action Plan in Section 5.21 in the MYC Handbook.

**Experience Unmatched Safety,
Comfort, and Connectivity.**

**Your Trusted Experts for
Homes, Businesses,
and Yacht Club.**

0451 793 646

Ben MacDonald

ben@wireempire.com.au

www.wireempire.com.au



ELECTRICAL • HVAC-R • DATA • SECURITY

Elec Lic. 255144c | R.T.A: AU41480 | Master Lic. 000100976

6. MYC JUNIOR AND YOUTH PROGRAM

6.1. INTRODUCTION

The Club is committed to introducing new sailors to the sport and supporting their development. The junior's program is for 8 to 18-year-olds, from novices to experienced racers, with the provision of qualified instructors.

MYC's commitment to making sailing accessible to all, has resulted in our unique "Club owned fleet". Our fleet of training O'pen Skiff Sports boats is available to junior members, providing a very cost-effective entry point to the sport.



The program is provided in partnership with Manly Sailing who are a commercial sailing school. They offer Level 1 and 2 courses and students who have completed Level 2 can join the MYC racing and Adventure fleets.

The cost of providing the racing and adventure fleet programs on a commercial basis is prohibitive and the MYC program is only sustainable because we rely on parents volunteering their time and skills. Hence only kids whose parents are prepared to volunteer are allowed to join.

PARENTAL ASSISTANCE IS A MANDATORY REQUIREMENT OF PARTICIPATION IN THE PROGRAM.

6.2. JUNIOR AND YOUTH BOATS SAILED

MYC supports three classes of sailing dinghies:

	<p>O'pen Skiff is an international class of high performance, single-handed dinghy. Ideal for experienced sailors in the 30-65kg ranges, the O'pen Skiff is an established and competitive racing fleet and provide the ideal platform for sailors to develop their skills. The O'pen Skiff is sailed with a 3.5m or 4.5m rig</p>
	<p>The ILCA 4 and 6 are based on a standard ILCA hull fitted with a smaller sail and amended mast. Suited to highly experienced sailors with minimum of 45 kg, the ILCA 4 is sailed mainly by teenagers. Meanwhile, the ILCA 6 is suited for 55-70 kg and is sailed by both teenagers and adults.</p>
	<p>Flying 11. Another Australian design, this high-performance sailing boat is ideally suited to teenagers and is a natural transition from junior dinghies to a range of senior international classes.</p>

6.3. CLUB-OWNED BOATS

MYC recognises the dilemma facing most parents when they want their kids to try sailing. It is expensive to buy a boat and if the child decides they don't want to continue then it has to be sold. The Club has solved this problem by buying fleets of O'pen Skiffs (both small and full rigs) that are used by Manly Sailing and Manly Yacht Club. Kids enrolled at Manly Sailing use the club boats and it is usual for kids moving into the club fleets to use the boats for about a season.

Those kids who have been sailing club boats for the longest will be asked to buy their own boat in order to make way for newcomers.

6.4. PRIVATELY-OWNED BOATS

The Club encourages families to buy their own boats and has some boat storage available. There is storage available for O'pen Skiffs and ILCAs.

6.5. SAILING PATHWAYS AT MYC

Explanatory notes for the Sailing Pathways diagram on the opposite page.

Manly Sailing: Manly Sailing is an independent organisation and sub tenant of Manly Yacht Club. It teaches all ages but has a focus on juniors and is affiliated with the Australian Sailing's "Start Sailing Levels 1, and 2".

Junior and Youth Fleets:

Manly Sailing takes junior sailors from non-sailors to Level 2. Once they have passed Level 2, they are introduced to the Manly Yacht Club Junior sailing program in the Sunday Green Fleet.

Fleet	Race Day	Class
Gold	Saturday Afternoon	O'pen Skiff (4.5m rig)
ILCA	Saturday Afternoon	ILCA 4 and ILCA 6
Silver	Sunday Afternoon	O'pen Skiff (3.5m & 4.5m rig)
Green	Sunday Afternoon	O'pen Skiff (3.5m rig)

**PITTWATER
ECO YHA**

**ONLY 1HR FROM
SYDNEY'S CBD**

- Affordable accommodation
- Kayak + SUP hire
- Veggie garden
- Great coffee
- Group catering options
- Corporate getaways
- Retreats
- Conservation Workshops
- Eco Tours and Yoga Classes

0436 808 528
PITTWATER@YHA.COM.AU

RETREATS, SCHOOL CAMPS,
CORPORATE GETAWAYS AND
FAMILY STAYS

PLAN YOUR NEXT ECO RETREAT
AT PITTWATER'S HIDDEN
PARADISE



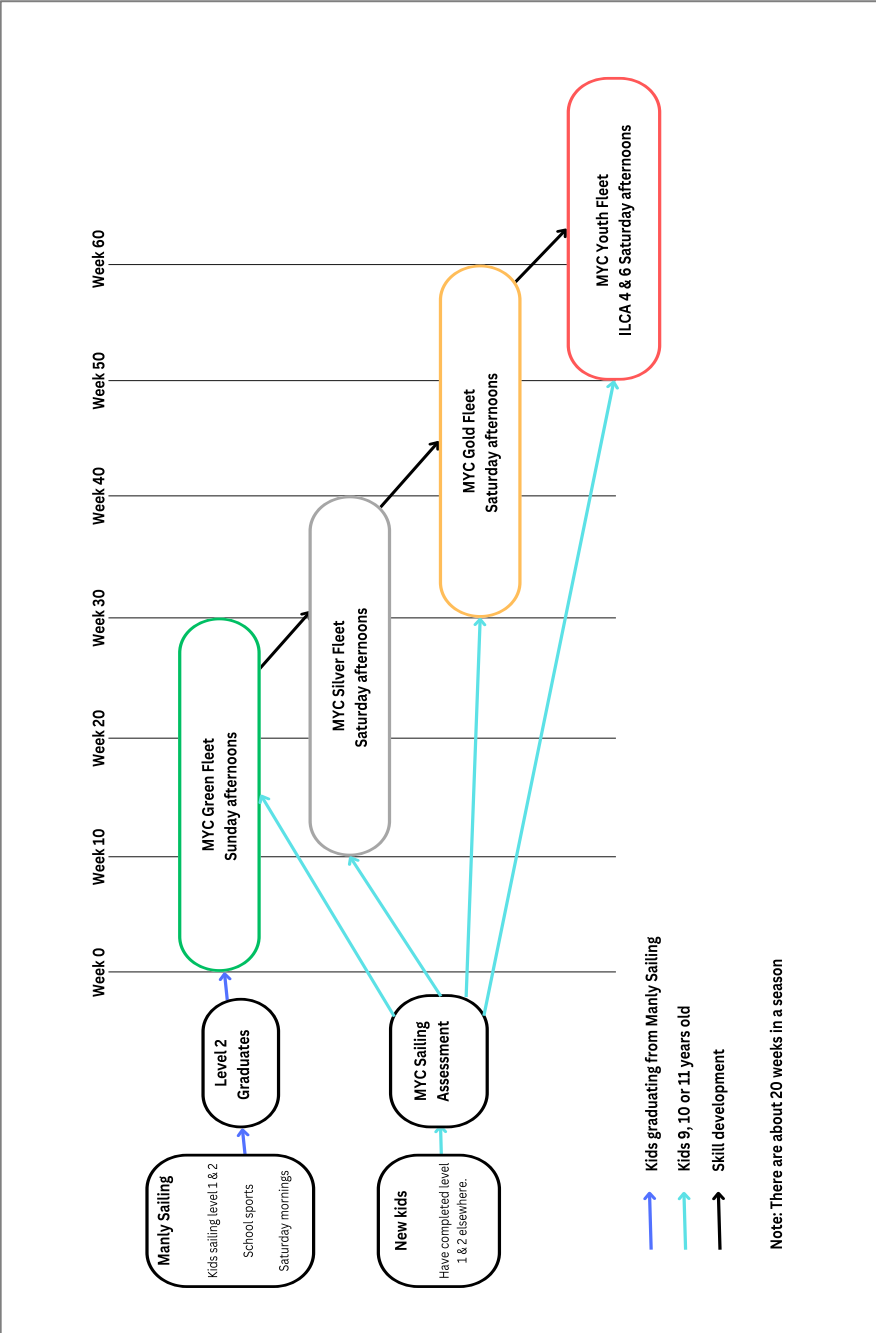

6.6. NEW RECRUITS

New recruits to our Junior Fleets usually come from Manly Sailing. Those who apply to join our program but who have not been students of Manly Sailing are known as New Kids.

Manly Sailing recommendations

Kids referred by Manly Sailing will enter Green Fleet sailing on Sundays, or the Silver Fleet, sailing on Saturdays, depending on their ability and body weight. These sessions will combine training, racing and fun exercises. Intakes to the Green and Silver fleets are made at the beginning of each season and again in February.

Children who show an ability to race properly and have completed Levels 1 & 2 may be promoted to the Gold fleet. This fleet provides a high level of competition and training. As well the kids can compete in the state championships and other events.

New Kids

If there are vacancies within the Junior Fleets that haven't been filled by Manly Sailing graduates, the Club will consider applications from New Kids. Factors such as their ability and experience, availability of club boats or racking for privately owned boats will need to be considered before the application can be accepted. All New Kids will need to undertake a sailing assessment conducted by our more experienced instructors who will recommend them to the Manly Sailing or MYC Junior Fleets as appropriate.

6.7. PARENTS INDUCTION COURSE

All parents have to complete an induction course before their children commence sailing. The course usually takes about an hour and explains how the Club works, what is required of parents and how the roster is set up.

6.8. JUNIORS PRE-REQUISITES

All Juniors must:

- Be invited to join the Juniors Program.
- Complete the registration process.
- Be confident swimmers and be able to swim 25 metres.
- Be sailing above AS Start Sailing Level 2
- Have the confidence to sail directly from the Club pontoon in the company of a Juniors support boat.
- Have parents who have completed the induction course.
- Have parents who are prepared to join the Roster.

6.9. JUNIORS GEAR (WHAT TO BRING WITH THEM)

Juniors must wear:

- Lifejackets (supplied at club or their own).
- Booties or other appropriate footwear (at all times, including on deck).
- Hat (preferably with chin strap or string lock).
- Sunscreen.

Recommended gear includes:

- Wetsuits – optional but recommended for early-Spring or late-Autumn. Board Shorts may be worn over wetsuits to avoid damage.
- Alternatively, swimming costume/board shorts with rashie (ideally long sleeve for sun protection and warmth).
- Drink Bottle (one you can afford to lose if they are carried in the boat).
- Bag (waterproof if possible).
- Sailing Gloves, Sunglasses.
- Towel and jumper or warm clothes to change into.
-

6.10. COMMUNICATIONS

All communication for the juniors will be via our WhatsApp group or email to juniors@myc.com.au. In the WhatsApp group, you will find the Parent Roster by clicking the group name at the top and then choosing the tab "Links". The Head Coach will also post the link in the group each week, so all parents can quickly check if they are rostered for the following Saturday and, as soon as possible, let the group know if they can't make it and start looking for a replacement.

6.11. RACING FLEETS

Overview

Manly Yacht Club's juniors are split into Gold, Silver and Green Fleets. Gold being the most experienced, followed by Silver and Green.

Green Fleet

The Green fleet is sailed in Small (3.5m) Rig O'pen Skiffs. They generally join the fleet after completing a learn to sail course (Level 1 & 2) with Manly Sailing.

They sail on Sunday afternoons. The sailing includes a mix of fun racing and sailing games and events such as the Capsize Cup and Splash Down Dash and a trophy will be awarded.

Silver & Gold Fleet:

As the sailors' skills improve they will move to Saturday sailing. This consists of the Silver and Gold Fleet sailing together with more of an emphasis on racing on a course set by volunteer parents with an on-water start and finish line. Silver Fleet focuses on introducing sailors to racing and how to improve their racing skills. The Silver Fleet have a separate start to the Gold Fleet with a focus on coaching to allow them to progress and not be intimidated by the more experienced Gold Fleet sailors. Gold Fleet sailors are generally older than Silver Fleet sailors and are encouraged to mentor and assist the Silver Fleet sailors. Both Silver and Gold Fleet sailors are encouraged to take part in O'pen Skiff regattas that take place at Manly Yacht Club and other sailing clubs all over the state and nationally.

ILCA Fleet:

Sailors generally move on from the O'pen Skiff at approximately 15 years of age. Although this depends on their body mass, it can be later, and it can be earlier. The next step is the ILCA 4 or ILCA 6. This is a dinghy designed for adults with a smaller (4.7m) sail designed for teenagers and young adults. The ILCA fleet sails on Saturday afternoons with the O'pen Skiff Silver & Gold Fleets.

Instructors and Parents

Instructors are rostered to accompany all fleets, and parents are required to skipper and crew support boats and committee vessel. Parents are also rostered on as Deck Captains and for the fuel run.

Training

Training will consist of theory, practice starts, upwind technique, downwind technique, mark roundings, boat handling tactics, racing rules, sail trim and some adventure sailing. The exact nature of the training will be announced at the skippers' briefing. It may also involve the fun stuff like capsizes, stand-up sailing, sailing backwards.

Training sessions will last about 60 to 120 minutes on the water, excluding the time it takes to rig, launch, and de-rig.

For some training sessions, sailors may be split up according to ability so that instructors can provide a more targeted lesson. These lessons may be structured to be part fun and serious.

Adventure Day

This may include 2-up sailing and other formats that will be both lots of fun and develop boat handling skills. The specific format will depend on weather conditions and sailor demand.

6.12. PARENTAL PARTICIPATION AND THE MANAGEMENT FRAMEWORK

We know parents are busy and any extra, unnecessary workload is not acceptable. Over the years our management systems have been streamlined so that only essential tasks are undertaken. For example, we know that kids won't rig their boats unless supervised; that we are required to provide support boats; kids won't learn to sail properly unless they are instructed; and dinghy racing is not taken seriously unless the racing is conducted properly. These are the key elements that need to be done properly.

On the one hand, we are trying to reduce the workload on parents but on the other hand we are required to manage a wide range of issues to make sure our junior sailing program can go ahead safely and smoothly.

At every session for all Racing Fleets:

Every child is required to have a parent to assist them to rig and de-rig whether an allocated club boat or their own boat. This includes carrying, rigging, attending briefings, launching retrieving, de-rigging, washing and stowing.

Children of 12 or more years are exempt from needing a parent if they can demonstrate an ability to rig and de-rig properly.

Standing Positions

A Race Director is appointed for the Junior and Youth Fleets. They are assisted by a Head Coach and report to the Board. They have the following responsibilities.

Standing Positions	
Juniors Racing Program Director	Board position and will be responsible for ensuring the program is meeting its objectives
Juniors Race Director	Responsible for overseeing all operations on race days, assisted by the Head Coach and reporting to the Juniors Racing Program Director
Head Coach	<ul style="list-style-type: none"> • Organise and assist with information meeting • Assist with registration • Assist with parents' induction course • Assist with rigging and boat equipment day • Provide and organise paperwork on sailing days • Manage parents' roster • Maintain WhatsApp • Seek instructors • Keep on file their qualifications • Manage instructors' roster • Keep kids' progression records • Make boat allocations • Deliver a training program for the Junior Fleets

Parents Roster

To ensure continuous and unbroken supervision of sailing activities by parents, a roster has been developed. Each sailing day parents are rostered onto the following positions: Deck Captains, Support Boat Crews, Race Committees and Fuel Duties.

Parents are required to acknowledge their rostered duties by Friday morning before the weekend through WhatsApp.

Parents may also be required at working bees, social events and for administrative duties.

Check the roster as soon as it is published and transfer your duties to your own personal diary. If you can't make a rostered day try and swap with another parent and, if you just can't, please contact the Head Coach as early as possible.

If you have issues or suggestions, talk to your fellow members – there's a lot of experience and it's likely someone has been there before, or has similar ideas that they want to develop. Communicate them to the Head Coach. We want this program to evolve into something better each season.

The Roster can be found on WhatsApp.

Scan the QR Code to join the group. For further information email the Head Coach at juniors@myc.org.au.



Parents Rostered Positions			
Position	Role / Job description	Silver & Green	Gold, ILCA 4 & ILCA 6
Deck Captain	<p>This requires an on-time arrival to unlock and set-up as well as late finish to pack up. Captain remains on Deck during sail activities to man the radio (in case of emergencies), assist in receiving any early retirements and to co-ordinate parents for reception of the fleet at the end of the session. They also have a role to ensure the sign on and off sheets are completed properly and that boats are rigged in the correct place in accordance with Section 5.21 Deck, Boats and Action Plan in the MYC Handbook.</p> <p>Issue Boat Holding Tags.</p>	✓	
Support Boat Crew	<p>The support boats to be used will be displayed in Section 5.21 Deck, Boats and Action Plan in the MYC Handbook and all skippers must hold a valid TfNSW boat licence. In addition, skippers must complete a short induction prior to taking control of a MYC support boat.</p> <p>Only a qualified crane licenced person can launch but crew are needed to prepare the support boat; support the instructor or Race Committee as they require; lay and retrieve marks as directed and return the boat to storage.</p>	✓	✓
Race Committee	<p>All racing is conducted in accordance with the Racing Rules of Sailing. A Race Committee is led by an experienced Race Officer and has overall control of the race area but works closely with the Instructor to ensure all competitors are comfortably sailing the course. The Race Committee sets courses; starts and finishes races; collects results and manages the race area.</p>	✗	✓
Fuel Duties	<p>They refill fuel cans. No Ethanol! The Payment Reimbursement Form is available on WhatsApp</p>	✓	

Instructors Roster

Most kids won't learn to sail without well targeted and trained instructors. It is often difficult for parents to teach their own kids to sail, whereas young, but qualified instructors, seem to connect with youngsters saying to them that sailing is in fact fun.

Manly Yacht Club employs qualified instructors from Australia and overseas to work with our Junior Fleets. Each sailing weekend, the instructors are rostered to manage fleets of 5 to 6 kids each.

6.13. GENERAL CONDITIONS OF RACING FOR JUNIOR & YOUTH FLEETS**6.13.1 RULES**

Racing is governed by:

- a) the current Racing Rules of Sailing (RRS) of World Sailing (WS) and the Australian Sailing Special Regulations ('The Blue Book').
- b) A vessel in breach of IRPCAS also known as COLREGS may be disqualified (DSQ) by the Race Committee.
- c) The current Sailing Instructions (SI), which may be amended. It is the competitor's responsibility to check for amendments. The Sailing Instructions may amend, delete or replace rules contained in the Racing Rules of Sailing, MYC General Conditions of Racing for Junior Fleets, and any Class Rules.

6.13.2 NOTICES TO COMPETITORS

Notices to Competitors will be posted on WhatsApp.

6.13.3 SIGNALS MADE ASHORE

Signals made ashore will be displayed on the MYC flagpole at the end of the jetty.

6.13.4 MARKS

MYC laid marks are orange spherical buoys.

6.13.5 AREAS THAT ARE OBSTRUCTIONS

- The areas of water between the outer line of all permanent moorings and the shoreline of Port Jackson shall be 'prohibited waters' for boats that are racing.
- All cardinal marks shall rank as 'obstructions' for boats that are racing and shall be passed on the side indicated on the cardinal mark, with the exception of the channel separation marker north of the Sow and Pigs reef.
- The area of water around any commercial ships, 30m on either side and astern and 500m ahead; or ferries, 30m on either side and astern, and 200m ahead - shall be an active exclusion zone and shall rank as an 'obstruction' for boats that are racing.

6.13.6 THE START

- The committee vessel will fly the MYC Burgee and an Orange Flag when it is on station.
- The starting line will be between the flagstaff on the committee vessel at the starboard end and an orange spherical buoy at the port end.
- The course number will be displayed on the committee vessel before the start.
- Boats whose warning signal has not been made should avoid the starting area.
- Individual and general recalls shall be in accordance with RRS 29. In the event of a general recall, the order of starting will not be altered.
- The warning signal of the next class/division will be made 3 minutes after the start of the previous class/division.
- Times shall be taken from visual signals; the failure of a sound signal shall be disregarded.
- A boat starting later than 9 minutes after her starting signal will be scored DNS. This changes RRS Appendix A4.
- Starts will be conducted with a Warning Signal 3 minutes prior to the Starting Signal. The preparatory signal shall be made 2 minutes prior to the starting signal. This changes RRS 26.

6.13.7 THE FINISH

- The committee vessel will fly the MYC Burgee and a Blue Flag when it is on station.
- The finishing line will be between the committee vessel flagstaff and an orange spherical buoy at either end of the line.

6.13.8 PENALTY SYSTEM

Your attention is drawn to RRS Rule 44.2 which states in part that 'a boat takes a One-Turn or Two-Turns Penalty by promptly making the required number of turns in the same direction, each turn including one tack and one gybe'.

6.13.9 PROTESTS

- Protests shall be in writing. A recommended Protest Form is available at the MYC Office and the MYC website www.myc.org.au.
- Protests shall be lodged at the MYC Office within two (2) hours after the time of the last boat's finish.
- Protests will be heard in approximately the order of receipt as soon as possible.

6.13.10 SCORING

- Rule A5.3 will apply.

6.13.11 PRIZES AND TROPHIES

- Perpetual trophies awarded by MYC are shown in Section 5.9, Trophies and Presentations in the MYC Handbook.
- Trophies will be presented on the Club's Presentation evening.

6.13.12 DISCLAIMER OF LIABILITY

Competitors participate in the racing entirely at their own risk. MYC will not accept any liability for material damage or personal injury or death sustained in conjunction with or prior to, during or after the racing. MYC is not responsible for the seaworthiness of a privately-owned boat whose entry is accepted or the sufficiency or adequacy of its equipment. MYC reserves the right to refuse an entry. Attention is drawn to RRS Rule 3 - Decision to Race.

6.13.13 INSURANCE

For MYC Juniors, ILCAs and all other boats racing at MYC, the entrant or their parents or guardians shall ensure that each participating boat is covered by the appropriate insurance.

6.14. ON DECK MANAGEMENT

Our deck is the central focus of our sailing program, but it is not big enough to rig, at one time, all the boats we hold in storage. In fact, we can't rig half the boats in storage and so we have to be clever; we need to use space efficiently and stagger our rig and launch times. For MYC it is a precious asset. Remember the deck is managed by the Deck Captains and users must do as they are asked.

Deck Etiquette

If properly organised there's plenty of space on the deck. Be aware of Section 5.21 Deck, Boats and Action Plan in the MYC Handbook and make sure you are rigging at the right time and in the correct place. If you need to tilt your boat to access the mast, try to minimise the time that the boat is tilted and hence reduce the disruption to others. Make sure your kids are on time for the briefings and launchings.

Launching support boats

The Deck Captain should assist the Head Coach, or better still, organise other parents to help prepare the support boats so that the deck is freed up for rigging. All support boats should be launched before any sailing boats are rigged, to increase deck space. To use the crane, you must participate in a short safety introduction to receive your licence.

Once the boats are launched, the inflatable boats' dollies, along with any racks can be rolled back into the boat storage area to make room for rigging.

The deck and equipment usage

We have two plans: Section 5.21 Deck, Boats and Action Plan tells you **WHEN** and Section 5.22 Deck Rigging Plan tells you **WHERE** to rig your boat. Often, not every boat scheduled to sail turns up, and if there is space and you want to start rigging early then that's fine, but if it becomes a full house you will have to give way.

Section 5.22 Deck Rigging Plan is for normal days, but on occasions we will have special events and a special rigging plan will be issued and posted on WhatsApp and on the Notice Board in the foyer of the ground floor of MYC before the pre-race briefing. Section 5.22 Deck Rigging Plan works well in south, easterly and north easterly wind, but for other directions the plan may need modification. For these winds the Deck Captains will modify the layout but keep the same general pattern.

Rigging boats

Arrive to sailing days with plenty of buffer time. Whatever can go wrong will go wrong at rigging time and it's better to have time to sort things out than rush equipment preparation. Make sure:

- The boat you are rigging is the one your instructor wants you to sail.
- Ensure each boat is FULLY RIGGED prior to taking it onto the pontoon to avoid delays.
- The mast, boom, centre board and rudder need to be properly secured in case of a capsized.
- Make sure the bungs are fitted properly.
- Tie your rudder on
- Fit your name tag.

Fleet Launches

All boats need to be launched at the times stated in Section 5.21 Deck, Boats and Action Plan. Each junior sailor is required to have a parent present to assist with the launching. Training each sailor on rudder/centreboard/sheet/launch routines will help speed up this process.

Fleet Retrieval

Unless otherwise announced (e.g. at the Sailor Briefing) all parents should be back on the pontoon by the times shown in Section 5.21 Deck, Boats and Action Plan. It's all hands-on deck and the process works best if everyone pitches in, don't wait until your own sailor arrives. Many hands make light work. Ultimately it is the responsibility of each parent to ensure that their kid's boat is washed and returned to the racks. Make sure that all salt is washed from blocks, ropes and especially cleats.

Locking up

The clubhouse contains a great many valuable boats and associated equipment and it needs to be locked up properly when not being used by its members. It is the Deck Captains' job to open and close the building for the junior's program. They do not have to lock the building if they can confirm that another user will do the job.

Jumping and diving from the wharf

Statistics show that jumping and diving into uncontrolled water is very dangerous and a risk assessment of our sailing program has identified diving from the MYC wharf as the most dangerous activity at the Club. **The MYC Board has banned jumping and diving from the wharf** and requests parents to be proactive in enforcing this rule. For more information see Section 4.4 MYC Wharf and Moorings in the MYC Handbook.

Support Boats

The Club owns the following support boats:

Boat	Description	Usage	Call sign	Capacity
Margo	Rigid Inflatable Boat	Support/Instructor	Margo	2 adults
Christabel	Rigid Inflatable Boat	Support/Instructor	Christabel	2 adults
Nigel Holman	Centre console RIB	Instructor for F11s	Nigel H	3 adults
Robbie R	Aluminium workboat	Mark laying	Robbie R	8 adults
Charlie's Chariot*	Aluminium workboat	Support/Mark laying	Cha Cha	3 adults
Ready, Get Set!!! **	displacement power boat	Committee vessel	Ready Get Set	8 adults

* Owned by Manly Sailability but loaned to MYC if required.

** On permanent loan.

These boats are dedicated to various purposes as shown in Section 5.21 Deck, Boats and Action Plan.

Abandonment of Sailing

Weather, equipment failure or other events may necessitate sailing to be abandoned.

The decision whether or not to launch will be made by the Head Coach or senior instructor for each fleet. An announcement will be made on the deck at about the time it becomes available for the particular fleet. In the event of severe weather forecasts the decision to abandon may be made after the 5pm forecast on the previous day and broadcast on WhatsApp.

The decision to abandon may also be made on the water if conditions become unexpectedly difficult. For the Gold & ILCA fleets this will be signalled in the usual way according to the RRS by the Race Committee (see also Section 5.20 Strong Wind Abandonment Guidelines in the MYC Handbook), and for the Silver and Green fleets the decision will be made by the Head Coach or senior instructor and conveyed to the boats by the instructors and parents.

Sign-on/off

For a variety of reasons from just knowing how well our services are being used, to the serious matter of responding to an on-water incident, the Club needs to know who is participating in its events. All Fleets need to sign on and off and this includes noting their sail number if appropriate.

Note that parents are allowed to sign on behalf of their children.

Instructors/Support Boat Briefing

To plan the day's activities properly and to respond to special circumstances, particularly the weather, Deck Captains, instructors and support boat drivers need to meet briefly before the on-water activities commence. They should confirm the program for the day, consider the latest weather forecasts and any special participants requirements, support boat availability etc.

Sailor Briefing

The sailors briefing for each fleet will be held on the deck, in the foyer or boat storage area at the times shown in Section 5.21 Deck, Boats and Action Plan. They confirm the program for the day, consider the latest weather forecasts and provide an opportunity for the instructors to lead the kids through the day's program.

Damaged Club Boats

The Club acknowledges the need for routine maintenance and also that damage to boats and equipment will occur from time to time. Of course, repeat offenders will be investigated but otherwise occasional damage simply needs to be repaired. If no action is taken, then the Manly Yacht Club and or Manly Sailing's program will be disrupted when the boats are next used.

The repair process is started by recording the damage in an email to juniors@myc.org.au and to info@manlysailing.com.au. These emails will warn other boat users that the boats are unserviceable, allowing them as much time as possible to make alternate arrangements.

Boat Licences

Our Juniors Program can't function without support boats, Race Committee and mark laying boats. All of these boats need to be skippered by parents with boat licences. If you do have a boat licence, please let the Head Coach juniors@myc.org.au know. If you don't have a licence, please consider getting one.

Other Club Members and Users

Juniors are one of many stakeholders in MYC. We share responsibility for the safe operation and maintenance of the Club and to operate with courtesy towards all members. Events are scheduled and rigging times are staggered so that there should be enough room and opportunity for all of us to sail. However, from time to time things can go wrong and we all have to give way a little and make things work.

Calendar of Events

The full list of events can be found in Section 5.8 MYC Calendar in the MYC Handbook.

Abbreviations can be found in Section 3 Abbreviations in the MYC Handbook. A legend of calendar events follows immediately after Section 5.8 MYC Calendar.

NEED A BREAK FROM SAILING?
WHY NOT CHILL OUT IN THE BLUE MOUNTAINS...
"ASHWOOD"
3-BEDROOM
MOUNTAIN COTTAGE
NEAR KATOOMBA FALLS



Enquiries: Contact Barry on 0423 519 863

7. GENERAL CONDITIONS OF RACING YACHTS, ILCAS AND SAILABILITY

7.1. RULES

7.1.1 Racing is governed by:

- a) The current Racing Rules of Sailing (RRS) of World Sailing (WS) and the Australian Sailing Special Regulations ('The Blue Book').
- b) IRCAS also known as COLREGS. A vessel in breach of COLREGS may be disqualified (DSQ) by the Race Committee.
- c) The current Sailing Instructions (SI), which may be amended. It is the competitor's responsibility to check for amendments. The Sailing Instructions may amend, delete or replace rules contained in the Racing Rules of Sailing, MYC General Conditions of Racing, and any Class Rules.
- d) As an amendment to RRS Rule 52, Manual Power, all boats are allowed to use an autopilot, whether in a Multi Crew, Short Handed or other Division.

7.1.2 The notation '[DP]' in a rule means that the penalty for a breach of that rule may, at the discretion of the protest committee, be less than disqualification. A boat that has broken such a rule, must provide a declaration to the Race Committee within the time limits set for protests.

7.1.3 The notation '[NP]' in a rule means that a boat may not protest another boat for breaking that rule. This changes RRS 60.1(a).

7.2. ELIGIBILITY AND ENTRY

7.2.1 [DP] All crew must be members of Australian Sailing or an equivalent international organisation.

7.2.2 [DP] All entrants are required to comply with the entry requirements of the Race Entry System.

7.2.3 Entries must be submitted, together with the required fee and supporting documentation 3 days prior to either the start of the series or any individual race. The Race Director has the discretion to accept entries.

7.2.4 [DP] [NP] Yachts (excluding ILCAs) should fly the MYC burgee during all Club events. The burgee must be flown with the blue portion down. An MYC burgee can be purchased from the MYC Office. Burgees from other clubs are acceptable.

7.3. EQUIPMENT AUDIT

7.3.1 All competing boats must hold an AS Equipment Audit Form of the category specified in the NOR and SI, including 'off the beach' boats. MYC does not certify the seaworthiness or suitability to race of any boat.

7.3.2 The AS Equipment Audit Form is valid for 12 months from the date of the inspection. MYC conducts Equipment Audit Inspections as shown in Section 5.8 MYC Calendar.

7.3.3 [DP] It is the owner's responsibility to ensure that the boat and equipment continue to comply in every way with the category in which the boat competes. Equipment must remain on the boat whilst racing, kept in good repair and working order and, if required, replaced during the season.

7.3.4 [DP] All yacht competitors must:

- a) Comply with the Transport for NSW and "COLREGS" requirement to display navigation lights from official sunset time to official sunrise time when a vessel is underway or at anchor.
- b) Comply with all TfNSW safety equipment requirements, including:
 - Carrying an efficient sound signal device
 - Carrying a waterproof torch: floating and working
 - Carrying 2 red and 2 orange flares when in open waters

- Displaying their TfNSW Registration Numbers on the transom in letters with a minimum height of 100 mm.
- c) Carry an AS-compliant lifebuoy with drogue and/or throw line ready for immediate use.
 - d) Carry a safety / space blanket for warmth.
 - e) Carry 2 substantial fenders.
 - f) Carry a VHF radio and a mobile phone whose number is known to the Race Committee.

7.4. NOTICE TO COMPETITORS

- 7.4.1 Notices to Competitors will be posted on the Official Notice Board on the MYC website www.myc.org.au and may be posted on the noticeboard at the foot of the stairs in the MYC lower foyer.
- 7.4.2 Handicaps will be posted on the Race Entry System and accessed on the MYC website www.myc.org.au and may be posted on the noticeboard at the foot of the stairs in the MYC lower foyer.

7.5. SAILING INSTRUCTIONS

- 7.5.1 The Sailing Instructions not already in the MYC Handbook will be available on the website www.myc.org.au prior to the first race in a series.

7.6. SIGNALS MADE ASHORE

- 7.6.1 Signals made ashore will be displayed on the MYC flagpole at the end of the jetty.
- 7.6.2 As a courtesy, the Race Committee may inform the fleet of relevant information via VHF and/or SMS messages.

7.7. MARKS

- 7.7.1 The approximate position of most marks is shown on the inside back cover of the MYC Handbook and on the MYC website www.myc.org.au.
- 7.7.2 MYC laid marks are inflatable buoys.
- 7.7.3 Shark Island, Clark Island, Fort Denison, Goat Island, Cockatoo Island, Snapper Island and Spectacle Island are islands, including all cardinal marks associated with the islands.
- 7.7.4 If a mark is missing and the Flag "M" is not in position, boats shall round or pass (as appropriate) the approximate position of the missing mark's stated location in the specified direction. This changes RRS 34.

7.8. AREAS THAT ARE OBSTRUCTIONS

- 7.8.1 [DP] The areas of water between the outer line of all permanent moorings and the shoreline of Port Jackson shall be 'prohibited waters' for boats that are racing.
- 7.8.2 [DP] All State and Federal exclusion zones shall rank as 'obstructions' for boats that are racing and shall not be entered.
- 7.8.3 [DP] All cardinal marks shall rank as 'obstructions' for boats that are racing and shall be passed on the side indicated on the cardinal mark, with the exception of the channel separation marker north of the Sow and Pigs reef.
- 7.8.4 [DP] The area of water around any commercial ships, 30m on either side and astern and 500m ahead; or ferries, 30m on either side and astern, and 200m ahead - shall be an active exclusion zone and shall rank as an 'obstruction' for boats that are racing.

7.9. RACE FORMATS

- 7.9.1 Scratch Races have a Scratch Start and results are calculated by Finish Order modified by any penalties.
- 7.9.2 TCF Races have a Scratch Start and results are calculated by applying a Corrected Time obtained from a boat's Elapsed Time modified by their handicap used as a Time Correction Factor and any penalties.
- 7.9.3 Pursuit Races have a Pursuit Start and the results are calculated by Finish Order modified by any penalties.
- 7.9.4 Pursuit TCF Races have a Pursuit Start and results are calculated by Corrected Time obtained from a boat's Elapsed Time modified by their handicap used as a Time Correction Factor and any penalties.

7.10. THE START (COMMITTEE VESSEL)

- 7.10.1 The committee vessel will fly the Burgee of an Organising Club and an Orange Flag when it is on station.
- 7.10.2 The starting line will be between the flagstaff on the committee vessel at the starboard end and an inflatable buoy at the port end.
- 7.10.3 Boats intending to race are required to report to the Race Officer aboard the committee vessel and shall receive acknowledgement. Failure to observe this requirement may result in a boat being disqualified.
- 7.10.4 The course number will be displayed on the committee vessel before the start.
- 7.10.5 Boats whose warning signal has not been made should avoid the starting area.
- 7.10.6 Individual and general recalls shall be in accordance with RRS 29. In the event of a general recall, the order of starting will not be altered.
- 7.10.7 The warning signal of the next class/division will be on the start of the previous class/division, unless the "AP" flag is displayed
- 7.10.8 Times shall be taken from visual signals; the failure of a sound signal shall be disregarded.
- 7.10.9 [DP] [NP] A boat starting later than 4 minutes after her starting signal will be scored DNS. This changes RRS Appendix A4.

7.11. THE START (CLUBHOUSE TRIANGLES)

- 7.11.1 Subject to 7.11.2, the starting line is west of the Manly Ferry path on a line which is the extension of a line joining the centre points of the two orange triangles on the MYC wharf and the upper deck of the clubhouse.
- 7.11.2 If the 'C' flag is displayed, the starting line is west of the Manly Ferry path on a line between a laid inflatable buoy and the top orange triangle on the MYC clubhouse.
- 7.11.3 For clubhouse line starts, the starting area is defined as the area bounded by the start line to the south (as per 7.11.1); the courtesy moorings to the north; and the Manly Ferry path to the east; and a transit in line with Manly Pavilion eastern wall to the west.
- 7.11.4 [DP] [NP] A boat identified by the Race Committee as having entered the starting area prior to her warning signal may have a penalty of 5 minutes added to her elapsed time. This amends RRS 63.1.
- 7.11.5 [DP] [NP] A boat starting earlier than 4 minutes before or later than 9 minutes after her starting signal may be scored DNS. This changes RRS Appendix A4.
- 7.11.6 The number of the course to be sailed will be displayed on a large board fixed to the MYC upper deck before the start time of the first boat.

7.12. THE START (SCRATCH RACE, TCF RACE)

- 7.12.1 Scratch Starts will be conducted according to RRS 26 with a Warning Signal 5 minutes prior to the Starting Signal.
- 7.12.2 When conducting multiple Scratch Starts in a sequence, the Warning Signal for a start shall be on the Start Signal of a preceding start, unless the "AP" flag is displayed.

7.13. THE START (PURSUIT RACE & PURSUIT TCF RACE)

- 7.13.1 There will be no countdown. Competitors should synchronise their watches to the clock displayed on the Manly Yacht Club website.
- 7.13.2 Each boat will have an individual allocated start time posted in accordance with the Sailing Instructions, subject to 7.13.10 rounded to the nearest minute.
- 7.13.3 Pursuit Races will have allocated start times calculated by applying a boat's PHS handicap to the expected course length and average conditions.
- 7.13.4 Pursuit TCF Races will have allocated start times calculated by applying a boat's PHS handicap to an arbitrary course length shorter than the expected course length and average conditions.
- 7.13.5 A boat may start at or after her allocated start time.
- 7.13.6 A boat's warning signal is the time 5 minutes prior to her allocated start time.
- 7.13.7 Practice starts are not permitted and may have a penalty of 5 minutes added to the boat's elapsed time.
- 7.13.8 A boat, which is OCS at its start time, will have the period that it crossed the start line early, rounded down to the nearest minute, added as a custom penalty included in its elapsed time. Furthermore, a 5-minute penalty will be added to its elapsed time for calculating its placing. A boat starting more than 4 minutes earlier than their allocated start time will be scored DNS. A boat may exonerate itself by restarting correctly.
- 7.13.9 There will be no recalls. This changes RRS 29.
- 7.13.10 The Race Committee may decide to postpone the start sequence, in which case they will display the 'L' Flag once the 'AP' Flag is dropped, to indicate that boats must contact the Race Committee to be informed of the size of the delay. Boats are to add the delay time to their allocated start time.
- 7.13.11 A boat's elapsed time is from the Allocated Start Time to the boat's finish time.

7.14. THE FINISH (COMMITTEE VESSEL)

- 7.14.1 The committee vessel will fly the Burgee of an Organising Club and a Blue Flag when it is on station. The committee vessel for the finish may be a different vessel and from a different Organising Club, than the committee vessel used for the start.
- 7.14.2 If the committee vessel is not on station; or for yachts, **if the committee vessel flies the yellow (Q) flag**, boats will finish on the MYC clubhouse triangles finish as per MYC Handbook 7.15.
- 7.14.3 RRS 41 (Outside Help) does not apply for the purposes of determining if the committee vessel is on station or if it is flying the yellow (Q) flag.
- 7.14.4 The finishing line for yachts will be between the committee vessel flagstaff and a yellow inflatable buoy which may be at either end of the line.
- 7.14.5 The finishing line for all other classes will be between the committee vessel flagstaff and an inflatable buoy at either end of the line.
- 7.14.6 The committee vessel may lay multiple lines at the same time. Competitors are reminded that RRS 23.1 (Interfering with another boat) applies to all competitors regardless of which line they are racing to.
- 7.14.7 Individual competitors who withdraw from the race, or who will not finish within the time limit, are required to notify the Race Committee as soon as possible after retirement. The Race Committee can be contacted in person at the clubhouse, or by telephone on 9977 4949 or radio VHF Ch 72.

GENERAL CONDITIONS OF RACING

- 7.14.8 If a boat has not finished or retired in a reasonable time after it was expected to finish, the Race Officer may call the Water Police.

7.15. THE FINISH (CLUBHOUSE TRIANGLES)

- 7.15.1 Subject to 7.15.2, boats will finish west of the Manly Ferry path on a line which is an extension of a line joining the centre points of the two orange triangles on the MYC jetty and the upper deck of the clubhouse.
- 7.15.2 If flag 'C' is displayed on the MYC flagpole at the end of the jetty, boats will finish west of the Manly Ferry path on a line between a laid inflatable buoy and the top orange triangle on the MYC clubhouse.
- 7.15.3 Individual competitors who withdraw from the race, or who will not finish within the time limit, are required to notify the Race Committee as soon as possible after retirement. The Race Committee can be contacted in person on the committee vessel or the clubhouse, or by telephone on 9977 4949 or radio VHF Ch 72.
- 7.15.4 If a boat has not finished or retired in a reasonable time after it was expected to finish, the Race Officer may call the Water Police. In the case of evening finishes the Race Officer may call the Police quite early because MYC has limited ability to conduct night searches.

7.16. HANDICAPS AND DIVISIONS

- 7.16.1 Handicaps for events with handicap starts will be assigned by the Race Directors, with the assistance of the Principal Handicapper, in accordance with the guidelines in the Sailing Instructions for the particular race series.
- 7.16.2 Divisions will be allocated by the Race Director. The decision will be based on the yacht's previous performance or its probable future performance. A written submission by the yacht's skipper or owner will be considered.
- 7.16.3 Handicaps will be set by the Race Committee and will not be subject to protest or request for redress.
- 7.16.4 The Race Directors or Principal Handicapper may at their absolute discretion review a boat's handicap where it is their opinion, due to an anomaly, error, change of racing trim or equipment or any other reason related to sailing, that the boat's handicap has become unfair or unreasonable.
- 7.16.5 A competitor must inform the Race Directors or Principal Handicapper of any change of racing trim or equipment that may affect the boat's handicap.
- 7.16.6 A division must be constituted by a minimum of four boats. This may be varied by the Notice of Race/Sailing Instructions.
- 7.16.7 Division allocations and Handicaps will be posted on the Race Entry System and accessed on the MYC website www.myc.org.au prior to the commencement of racing.

7.17. PHS HANDICAPS - SAILSYS RACE MANAGEMENT SYSTEM

- 7.17.1 The handicap assigned to a boat is the Performance Handicap System (PHS) which is a 4-decimal number. A boat's PHS may be applied as a Time Correction Factor (TCF) to a boat's Elapsed Time to obtain a Corrected Time, and/or combined with a course length and estimated conditions to obtain an individual Allocated Start Time.
- 7.17.2 After each race a Race TCF will be computed for each boat such that if each boat's Race TCF was applied to its elapsed time for that race, all boats would have finished at the same corrected time. If a boat fails to finish, no Race TCF is calculated. For each competitor, the Race TCF = Reference Time / Competitor's Elapsed Time whereby the Reference Time is the corrected time of the competitor who is calculated as the "benchmark" boat for the day. The "benchmark" boat will vary depending on the conditions on the day.
- 7.17.3 The Race TCF will have upper and lower clamps applied to it which may vary depending on the nature of the event. The upper clamp will always be applied in any series and defaults to 5%. The lower clamp will vary depending on the series and defaults to 8%. If a Race TCF is outside the range enclosed by these clamps, then the clamped value will be substituted. The PHS for the next race is then calculated for each boat as the average of the Race TCF's for the chosen number of races to be considered in the series, excluding the worst.

7.18. PENALTY SYSTEM

- 7.18.1 Your attention is drawn to RRS Rule 44.2 which states in part that 'a boat takes a One-Turn or Two-Turns Penalty by promptly making the required number of turns in the same direction, each turn including one tack and one gybe'.
- 7.18.2 The Sailing Instructions may allow a Discretionary Penalty to be applied.

7.19. PROTESTS, ARBITRATION AND REDRESS

- 7.19.1 Protests shall be in writing. A recommended Protest Form is available at the MYC Office and the MYC website www.myc.org.au.
- 7.19.2 Protests will be heard in approximately the order of receipt as soon as possible.
- 7.19.3 Protests may be resolved by arbitration where all of the following apply:
- There is an alleged breach of RRS Rule 31 or a rule in Part 2 of RRS
 - There was no contact that caused serious damage or injury
 - The protest is between two boats
 - Both parties agree to arbitration
 - An arbitrator acceptable to both parties is available and is appointed by the Race Committee

This changes Part 5, Section B of the RRS.

- 7.19.4 The arbitration shall apply RRS Appendix T.
- 7.19.5 A boat that accepts the arbitrator's opinion that she broke a RRS Rule of Part 2 or RRS Rule 31 shall receive a Discretionary Penalty as detailed in the Sailing Instructions. If the Sailing Instructions do not explicitly allow a Discretionary Penalty, then arbitration may still occur but a boat that accepts she broke a rule will be scored RET. Acceptance of a Discretionary Penalty cannot be grounds for redress or be appealed.
- 7.19.6 The arbitrator will not be a member of a Jury that hears the protest but will be permitted to observe the testimony given to the Jury and offer testimony. This changes RRS 63.3(a).
- 7.19.7 Protests that are not resolved by arbitration will be heard by the MYC in accordance with RRS Part 5 Section B and following the recommendations of RRS Appendix M3.

7.20. USE OF PROPULSION

- 7.20.1 A boat that is racing may use her engine or other propulsion in accordance with RRS 42.3(i):
- a) To get to within a distance of 50m of the starting line, up until 1 minute of her starting signal, or,
 - b) For safety or other extraordinary reasons.
- 7.20.2 A boat using propulsion under 7.20.1 shall take a one-turn penalty as described in RRS rule 44.2 after disengaging the propulsion.
- 7.20.3 A boat using propulsion under 7.20.1 (b) shall provide a propulsion declaration to the Race Committee within the protest limit time. This declaration shall detail the reason, location, time and duration of propulsion.
- 7.20.4 The Protest Committee, at its sole discretion, may impose a time or scoring penalty for use of propulsion under 7.20.1 (b).
- 7.20.5 While under propulsion, the rules of Part 2 are replaced by right-of-way rules of the IRPCAS.
- 7.20.6 [DP] If reasonably possible, a boat using propulsion shall not interfere with a boat that is racing.

7.21. SCORING

- 7.21.1 TCF and Pursuit TCF Races will use a boat's elapsed time modified by her handicap and penalties to determine her place in a race.
- 7.21.2 Scratch Races and Pursuit Races will use a boat's finish order modified by any penalties to determine her place in a race.
- 7.21.3 The Low Point Scoring System RRS, Appendix A4 will apply; modified so each boat's series score will be the total of her race scores, with her worst scores discarded if allowed by the Sailing Instructions.
- 7.21.4 Series Scoring System RRS, Appendix A5.3 will apply. Unless modified, this means a boat recording a DNS, OCS, DNF, NSC, DSQ, DNE or RET shall be scored points for the finishing place one more than the number of boats that came to the starting area, and a DNC boat shall be scored points for the finishing place one more than the number of boats entered in the series.
- 7.21.5 For all Pursuit and Pursuit TCF Races, 7.21.4 is modified to allow the Race Committee to apply a custom time penalty to OCS boats in accordance with 7.13.8 and score such boats as finishing the race with amended finish times.
- 7.21.6 The number of races required to constitute a series will be two less than the number of races scheduled in the series except where the number of races to constitute a series is in the Sailing Instructions.
- 7.21.7 Boats which have not crossed the finishing line by the time limit will be scored DNF.
- 7.21.8 If a boat is unable to race due to MYC race management duties of the skipper or crew, the skipper may request average points. At the discretion of the Sailing Committee, average points will be awarded using a calculation documented in RRS A9 (a) "points equal to the average, to the nearest tenth of a point (0.05 to be rounded upward), of her points in all the races in the series except the race in question;". A boat may claim average points for race management duties no more than once per series (or twice for the Twilight Series) and three times per season for all series. The Sailing Committee decision will be based on the contribution of a duty boat to the race committee, with the exception that a duty boat provide a material contribution to that race committee (noting that smaller boats have smaller crews). Average points will not be awarded to boats that participate in a race.
- 7.21.9 The Sailing Committee may, at its sole discretion, award average points where, due to conflicts with representing MYC in State, National or International Events, a yacht is unable to compete in a race of a series for which it has nominated. Skippers are advised to seek pre-approval from the Sailing Committee.

7.21.10 Casual race entries will receive a place but no race score. Casual boats will be excluded from race score calculations so that casual boats will have no effect on series scores.

7.22. RESULTS

7.22.1 When possible, yacht and ILCA race results will be announced at the MYC clubhouse following the race. Results will be posted on the Race Entry System and accessed on the MYC website www.myc.org.au. Results of all divisions may be published in the next edition of the MYC newsletter.

7.22.2 All results are provisional until Presentation Night.

7.23. SAFETY REGULATIONS

7.23.1 Yacht Skippers must read and acknowledge the MYC Safety Briefing, a copy of which is available from the MYC office and on the MYC website www.myc.org.au.

7.23.2 Competitors must be aware of:

- a) Section 5.15 Risk Warning in the MYC Handbook.
- b) Section 5.16 Risk Assessment in the MYC Handbook.
- c) Section 5.17 Safety Plan for Competitors in the MYC Handbook.
- d) Section 5.18 Emergency Communications in the MYC Handbook.
- e) Section 5.19 Incident Reporting in the MYC Handbook.

7.23.3 [DP] It is the responsibility of Yacht Skippers:

- a) to ensure the crew know where Life Saving Equipment is stowed on their boat and how to use it.
- b) to practice man overboard procedures with the crew regularly as per AS Special Regulations Section 8 Appendix D.
- c) to make sure they and the crew know how to locate, wear and operate a PFD.
- d) to notify the Race Committee of their intention to start a race as directed in the Sailing Instructions.

7.23.4 MYC is not in a position to provide support or assistance to boats and crew during the course of a race. Manly Yacht Club relies on external resources for all emergency situations.

7.23.5 [DP] Competitors must keep clear of commercial shipping, defence shipping, ferries displaying orange diamonds and vessels engaged in towing.

7.23.6 [DP] An active exclusion zone exists around ships and ferries that extends 30m to either side; 30m from the stern; 200m ahead of a ferry and 500m ahead of any ship. Competitors must not pass between a ship and an escort vessel.

7.23.7 Strong wind and abandonment guidelines can be found in Section 5.20 Strong Wind Abandonment Guidelines in the MYC Handbook.

7.23.8 [DP] Competitors and competing boats shall comply with any additional safety requirements or other obligations specified in the Notice of Race or Sailing Instructions, as amended from time to time. This includes any requirements concerning a COVID-19 safe environment for sailing staff, event/course participants and members.

7.23.9 [DP] [NP] All Yachts are required to maintain a listening watch on VHF channel 72 at all times when intending to race and whilst racing. The Race Committee will use this channel to communicate to the MYC fleet for race management and safety reasons. (Be aware that sometimes the Sailing Instructions MAY nominate an alternative channel which needs to be monitored instead, but otherwise VHF 72 is the default.) Failure of a yacht to respond to a call on channel 72 will not be grounds for a protest.

7.24. PRIZES AND TROPHIES

- 7.24.1 Perpetual trophies awarded by MYC are shown in Section 5.9, Trophies and Presentations in the MYC Handbook.
- 7.24.2 Unless otherwise specified in the Sailing Instructions, race prizes will be presented at the presentation after the race. Skippers or nominated representatives must be present to collect the prize, otherwise it will jackpot to the next place.
- 7.24.3 Unless otherwise specified in the Sailing Instructions, major prizes 'drawn from the barrel' will be presented on the last scheduled day of sailing for that series. Skippers or a nominated representative must be present to collect the prize, otherwise the prize will be redrawn.
- 7.24.4 When a prize is 'drawn from the barrel', names of race entries for each race for each division will have one entry in the barrel. Third place in a race for each division allows one extra name in the barrel. Second place in a race for each division allows two extra names in the barrel. First place in a race for each division allows three extra names in the barrel.
- 7.24.5 Trophies will be presented on the Club's Presentation evening.
- 7.24.6 Casual entries are excluded from winning major prizes but may win individual race prizes.

7.25. DISCLAIMER OF LIABILITY

- 7.25.1 Competitors participate in the racing entirely at their own risk. MYC will not accept any liability for material damage or personal injury or death sustained in conjunction with or prior to, during or after the racing. MYC is not responsible for the seaworthiness of a boat whose entry is accepted or the sufficiency or adequacy of its equipment. MYC reserves the right to refuse an entry. Attention is drawn to RRS Rule 3 - Decision to Race.

7.26. INSURANCE

- 7.26.1 For all yachts racing at MYC, each participating boat shall be insured with valid third-party liability insurance with a minimum cover of \$10 million per event or the equivalent. A current Certificate of Currency for this insurance must be held on file at MYC and the owner must upload or otherwise provide a new certificate on renewal during the racing season.
- 7.26.2 For ILCAs and all other boats racing at MYC, the entrant or their parents or guardians shall ensure that each participating boat is covered by the appropriate insurance.

7.27. SAIL NUMBERS

- 7.27.1 Members requiring a sail number can apply to MYC for a MYC sail number or apply directly to the Australian Sailing. For further information contact the Club Manager.

7.28. RACE COMMITTEE

- 7.28.1 The Race Committee will be appointed by the Sailing Committee of MYC. The Sailing Committee has the power to appoint specific club members to be the Race Committee for particular events or purposes. For further information about the Race Committee and its functions contact the Principal Race Officer nominated in section 1.5 of the MYC Handbook or email dutyroster@myc.org.au.

7.29. CLUB REPRESENTATION

- 7.29.1 Where MYC is invited to nominate representatives to sail in inter-club, AS, State, National or International events the nomination will be decided by the Sailing Committee.

7.30. DUTY BOAT

- 7.30.1 An MYC vessel that enters an MYC Series may be allocated a date to be duty boat when they must provide members for the Race Committee. Typically, duty boat allocations will be made a few months in advance.
- 7.30.2 A vessel may be allocated a duty date either for a race in the series they have entered or from another MYC series.
- 7.30.3 If an allocated duty date is not suitable, a vessel may organise to swap dates with another vessel and then inform dutyroster@myc.org.au of the agreed swap. All swaps must be notified at least two weeks prior to the race date. If necessary, dutyroster@myc.org.au can forward contact details to another boat.
- 7.30.4 If a vessel is unable to sail a race because they are a duty boat, they may seek redress according to Section 7.21.8 Scoring. However, there is no requirement for a boat not to sail when on duty, so long as sufficient Race Committee members are provided.
- 7.30.5 A duty yacht must provide the required number of adults and a duty ILCA must provide one adult, to be members of the Race Committee for on water races. Typically, the Race Committee members are from the vessel's regular crew, but they may also be from friends and/or family, so long as they are able to carry out the tasks required and are AS members if they perform on-water tasks. Twilight duty is entirely shore-based requiring a minimum of 3 people.
- 7.30.6 [DP] When allocated a duty date, a vessel must confirm their availability and provide the names of the team's members to dutyroster@myc.org.au within two weeks after the allocation, including an indication if they are unable to provide an experienced Race Officer and/or boat driver. The names provided may subsequently be changed by giving notice to dutyroster@myc.org.au.
- 7.30.7 [DP] It is compulsory for all racing yachts to provide one person each season for Race Officer training.
- 7.30.8 It is expected that the duty yacht will provide an appropriately trained and experienced Race Officer, capable of running any yacht, ILCA and junior races scheduled for that day. However, an additional experienced Race Officer may be allocated to assist the less experienced race management teams.
- 7.30.9 It is recommended for all Race Committee participants to attend a Race Officer's training course as they can expect to be fully utilised as a part of the race management team including course setting, mark laying and retrieval, and starting, conducting and finishing the race. It is also recommended that all participants review the training and documentation sections on the MYC website www.myc.org.au with documents including "How to operate support boats". In addition, we do expect at least 1 participant to hold a Boat Driver's Licence, and 1 participant to hold the VHF Marine Radio Operator's licence.
- 7.30.10 A vessel that fails to meet their duty boat obligations, including failing to provide information within the time limits above, will be disqualified from the next "finished" MYC race in which they are a series entrant. If racing must be abandoned due to the non-availability of duty boat personnel, then the duty boat will be scored with a non-excludable disqualification from the next two races. If there are extenuating circumstances, the vessel may apply for redress to request a lesser penalty.

KTRONICS

ELECTRONIC SECURITY SOLUTIONS

www.ktronics.com.au | ML:102039 | ABN: 54 169 716 527

Email: enquiries@ktronics.com.au

Proudly Supporting MYC

Keeping you safe, secure, connected...

With years of industry experience, our team of highly skilled professionals is equipped with the knowledge and expertise to design and implement customized security systems tailored to your unique needs. Whether you require a comprehensive surveillance system, access control solutions, or alarm monitoring services, we have you covered.



Back-to-base monitoring...

Your safety is our top priority, which is why we provide round-the-clock monitoring services. Our advanced monitoring centres are staffed by trained professionals who promptly respond to any potential threats, ensuring rapid action and swift resolution in critical situations.

Your safety matters...

As an esteemed family-owned business, we recognize the criticality of customizing our services to cater to the unique requirements of commercial clients. We meticulously design security systems that seamlessly integrate into your commercial operations, allowing you to focus on your core business activities. Count on us to deliver a tailored security solution that not only aligns with your specific needs but also ensures the utmost protection and peace of mind your business deserves.



Please get in touch for a quote or to have a chat! Our friendly team is here to help.



Link to our website

Celebrating

20

Years

PO Box 147
Narrabeen NSW 2101
Australia

Office 1300 621 060

Control Room 1300 621 006

8. SAILABILITY NOR & SI

SAILABILITY REGATTAS – NOR

1. Rules

- 1.1 The racing will be governed by the rules as defined in the Racing Rules of Sailing (RRS) and the General Conditions of Racing as defined by Section 7 of the MYC Handbook and the prescriptions of the Australian Hansa Class Association, except as altered by the Sailing Instructions which are also considered part of the rules.
- 1.2 The Organising Authority may amend this Notice of Race. Amendments will be published on the Official Notice Board on the MYC website.

2. Eligibility and Entry

- 2.1 The racing is open to Hansa Dinghies.
- 2.2 Boats must hold a current 'Off the Beach' Boat Registration and Compliance Declaration.
- 2.3 Eligible skippers will be contacted by the Race Director and shall be allocated to a boat. This will be posted on the Official Notice Board by 0900 hrs on the day of racing and may be placed on the Notice Board located on the ground floor foyer of MYC.
- 2.4 A division must be constituted by a minimum of four boats.

3. Fees

- 3.1 Entry fees are listed in Section 5.1, Racing Fees in the MYC Handbook.

4. Schedule

- 4.1 Sailability Regattas are described in Section 5.8 MYC Calendar as SR (Sailability Regatta) and SADR (Sailability Australia Day Regatta).
- 4.2 The day and date of each race is shown in Section 5.8 MYC Calendar.
- 4.3 The following classes/divisions will be sailed:
 - Hansa Dinghy
- 4.4 There are up to 3 races scheduled for each regatta.
- 4.5 The warning signal is shown in the Sailing Instructions.

5. Racing Area

- 5.1 Racing will be conducted in Manly Cove.

6. Scoring

- 6.1 No score will be discarded.

7. The Courses

- 7.1 Courses are described in the Sailing Instructions.

8. Prizes

- 8.1 Prizes will be awarded to first on scratch. Other prizes may be awarded at the discretion of the Race Committee.
- 8.2 Hansa Dinghy results for the Wayne Black Trophy will include scores from all Sailability Regattas conducted by MYC.

9. Further Information

- 9.1 A BBQ, presentation and get together will be held on the deck of MYC after racing.

SAILABILITY REGATTAS – SI

1. Rules

1.1 The racing will be governed by the rules as defined in the Racing Rules of Sailing (RRS) and the General Conditions of Racing as defined by Section 7 of the MYC Handbook and the prescriptions of the Australian Hansa Class Association, except as altered by the Sailing Instructions which are also considered part of the rules.

2. Schedule of Races

2.1 Sailability Regattas are described in Section 5.8 MYC Calendar as SR (Sailability Regatta) and SADR (Sailability Australia Day Regatta).

2.2 The day and date of each race is shown in Section 5.8 MYC Calendar.

2.3 There are up to 3 Scratch Start Handicap Races scheduled each regatta.

2.4 The following classes/divisions will be sailed:

- Hansa Dinghy

2.5 When more than one race will be held on the same day, the warning signal for the first race and each succeeding race will be made as soon as practicable.

2.6 The scheduled time of the warning signal is shown below (to be read in conjunction with RRS 26). Races will be started no earlier than times shown. Times shall be taken from visual signals; the failure of a sound signal shall be disregarded.

WARNING	CLASS/DIVISION	FLAG
1000 hrs	Hansa Dinghy	Numeral Pennant 1

3. Class Flags

3.1 The Class flags will be as follows:

CLASS	FLAG
Hansa Dinghy	Numeral Pennant 1

4. Racing Area

4.1 Racing will be conducted in Manly Cove.

5. The Courses

5.1 The courses are shown as follows:

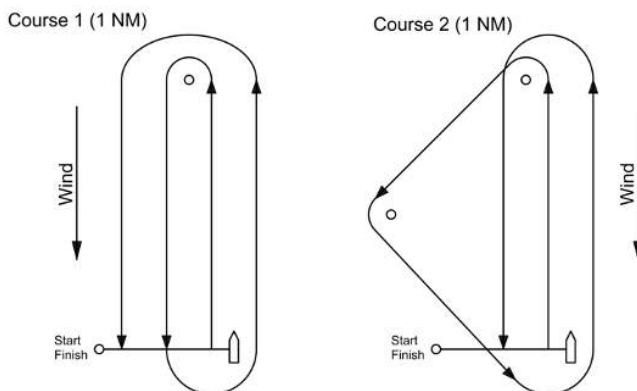

5.2 The number of the course to be sailed will be displayed on the committee vessel before the start.

6. Marks

6.1 All marks will be inflatable buoys.

7. The Start

7.1 Races will be started by using RRS Rule 26.

7.2 All races will be scratch starts from the committee vessel line as described in Sections 7.10 and 7.12 General Conditions of Racing.

8. The Finish

8.1 The finish will be on the committee vessel line as described in Section 7.14 General Conditions of Racing.

9. Penalty System

9.1 Your attention is drawn to RRS 44.1 and RRS 44.2. RRS 44.2 states in part that ‘a boat takes a One-Turn or Two-Turns Penalty promptly by making the required turns in the same direction, each including one tack and one gybe’.

10. Time Limits

10.1 The time limit for each race will be at least 30 minutes or longer at the Race Officer’s discretion.

11. Prizes

11.1 Prizes will be awarded to first on scratch. Other prizes may be awarded at the discretion of the Race Committee.







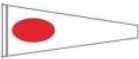

11.2 Hansa Dinghy results for the Wayne Black Trophy will include scores from all Sailability Regattas conducted by MYC.

12. Further Information

12.1 A BBQ, presentation and get together will be held on the deck of MYC after racing.

**SAILABILITY REGATTA
START SEQUENCE**

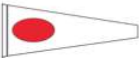

<p>5 MINUTES NUMERAL PENNANT 1 UP</p>		
<p>4 MINUTES PREPARATORY P-FLAG UP</p>		
<p>1 MINUTE PREPARATORY P-FLAG DOWN</p>		
<p>0 MINUTE NUMERAL PENNANT 1 DOWN</p>		

OTHER FLAGS



AP FLAG – POSTPONEMENT USED TO POSTPONE THE START OF A RACE

HOW USED:

- When the start of a race is to be postponed, the AP Flag will be raised with 2 sound signals.
- When racing can resume, the AP Flag is lowered with 1 sound signal.
- The start sequence will commence 1 minute after the lowering of the AP Flag



L FLAG – COME WITHIN HAIL USED TO GET THE COMPETITORS TO COME CLOSE TO THE START BOAT FOR FURTHER INSTRUCTION

HOW USED:

- Raised before or between races if required.

ABANDONING RACING

Various variations of N, or N over H, or N over A flags
3 sound signals when N Flag raised



N FLAG – ABANDON

USED TO ABANDON A RACE

1 sound signal when N Flag lowered
1 minute before start sequence commences

OR



N FLAG OVER H FLAG

USED TO ABANDON ALL RACES – SIGNALS ASHORE

All boats off the water



OR



N FLAG OVER A FLAG

USED TO ABANDON ALL RACES – NO MORE RACING TODAY

All boats off the water



9. JUNIOR & YOUTH NOR & SI

JUNIOR & YOUTH CLUB CHAMPIONSHIP – NOR

1. Rules

- 1.1 The racing will be governed by the rules as defined in the Racing Rules of Sailing (RRS) and Section 6.13 General Conditions of Racing for Junior Fleets as defined by of the MYC Handbook, and any applicable class/association rules, except as altered by the Sailing Instructions which are also considered part of the rules.
- 1.2 The Organising Authority may amend this Notice of Race. Amendments made prior to the race day will be posted on WhatsApp and displayed on the Notice Board located on the ground floor of MYC. Amendments thereafter shall be published on the Notice Board located on the ground floor of MYC prior to the pre-race briefing.

2. Eligibility and Entry

- 2.1 Racing is open to Junior classes:
 - O'pen Skiff
 - ILCA 4
- 2.2 Boats must hold a current 'Off the Beach' Boat Registration and Compliance Declaration.
- 2.3 A class must be constituted by a minimum of 3 boats.

3. Fees

- 3.1 There is no entry fee for junior classes.

4. Schedule

- 4.1 The schedule of race days is shown in Section 5.8 MYC Calendar.
- 4.2 All races are Scratch Races.
- 4.3 The classes/divisions to be sailed will be determined by the eligible boats registered.

5. Racing Area

- 5.1 Racing will be conducted in North Harbour and Manly Cove.

JUNIOR & YOUTH CLUB CHAMPIONSHIP – SI

1. Rules

- 1.1 The racing will be governed by the rules as defined in the Racing Rules of Sailing (RRS) and Section 6.13 General Conditions of Racing for Junior Fleets as defined by of the MYC Handbook, and any applicable class/association rules, except as altered by the Sailing Instructions which are also considered part of the rules.

2. Schedule of Races

- 2.1 The schedule of race days is shown in Section 5.8 MYC Calendar.
 2.2 All Races are Scratch Races.
 2.3 There will be a pre-race briefing on the MYC Rigging deck at 1250 hrs.
 2.4 The classes to be sailed will be announced at the pre-race briefing.
 2.5 The scheduled time of the warning signal for the earliest race is 1420 hrs.
 2.6 The order of the classes/divisions to be sailed will be announced during the pre-race briefing.
 2.7 When more than one race will be held on the same day, the warning signal for each succeeding race will be made as soon as practicable after the finish of the previous race.

3. Class Flags

- 3.1 The class flags will be as follows:

CLASS	FLAG
O'pen Skiff	O'pen Skiff class flag
ILCA 4	Green flag with a Red Laser emblem

4. The Courses

- 4.1 Courses are shown in Appendix 12.A1. Note: Classes may sail a different course; the course number being displayed on the committee vessel.

5. The Start

- 5.1 Races will be started by using RRS Rule 26.
 5.2 The start will be on the committee vessel line as described in Section 6.13.6 General Conditions of Racing for Junior & Youth Fleets.

6. The Finish

- 6.1 The finish will be on the committee vessel line as described in Section 6.13.7 General Conditions of Racing for Junior & Youth Fleets.

7. Time Limits

- 7.1 The time limit for each race is 90 minutes or shorter at the discretion of the Race Committee.

8. Scoring

- 8.1 The number of races scheduled for the series is shown in Section 5.8 MYC Calendar.
 8.2 The number of races required to constitute a series will be 4 less than the number of races scheduled in the series.
 8.3 Each boat's series score will be the total of her race scores, with her worst 2 scores discarded.

JUNIOR & YOUTH HANDICAP POINT SCORES – NOR

1. Rules

- 1.1 The racing will be governed by the rules as defined in the Racing Rules of Sailing (RRS) and Section 6.13 General Conditions of Racing for Junior Fleets as defined by of the MYC Handbook, and any applicable class/association rules, except as altered by the Sailing Instructions which are also considered part of the rules.
- 1.2 The Organising Authority may amend this Notice of Race. Amendments made prior to the race day will be posted on WhatsApp and displayed on the Notice Board located on the ground floor of MYC. Amendments thereafter shall be published on the Notice Board located on the ground floor of MYC prior to the pre-race briefing.

2. Eligibility and Entry

- 2.1 Racing is open to the following classes:
 - O'pen Skiff
 - ILCA 4
 - ILCA 6
- 2.2 Boats must hold a current 'Off the Beach' Boat Registration and Compliance Declaration.
- 2.3 A class must be constituted by a minimum of 3 boats.

3. Fees

- 3.1 There is no entry fee for junior classes.

4. Schedule

- 4.1 The schedule of race days is shown in Section 5.8 MYC Calendar.
- 4.2 Races are Scratch Start Handicap Races.

5. Racing Area

- 5.1 Racing will be conducted in North Harbour and Manly Cove.

JUNIOR & YOUTH HANDICAP POINT SCORES – SI

1. Rules

- 1.1 The racing will be governed by the rules as defined in the Racing Rules of Sailing (RRS) and Section 6.13 General Conditions of Racing for Junior Fleets as defined by of the MYC Handbook, and any applicable class/association rules, except as altered by the Sailing Instructions which are also considered part of the rules.

2. Schedule of Races

- 2.1 The schedule of race days is shown in Section 5.8 MYC Calendar.
 2.2 All races are Scratch Start Handicap Races.
 2.3 There will be a pre-race briefing on the MYC Rigging deck at 1250 hrs.
 2.4 The classes to be sailed will be announced at the pre-race briefing.
 2.5 The scheduled time of the warning signal for the earliest race is 1420 hrs.
 2.6 The handicap of each boat will be posted on WhatsApp and displayed on the Notice Board located on the ground floor of MYC prior to the pre-race briefing.
 2.7 When more than one race will be held on the same day, the warning signal for each succeeding race will be made as soon as practicable after the finish of the previous race.

3. Class Flags

- 3.1 The class flags will be as follows:

CLASS	FLAG
O'pen Skiff	O'pen Skiff class flag
ILCA 4	Green flag with a Red Laser emblem
ILCA 6	Green flag with a Red Laser emblem

4. The Courses

- 4.1 Courses are shown in Appendix 12.A1. Note: Classes may sail a different course; the course number being displayed on the committee vessel.

5. The Start

- 5.1 Races will be started by using RRS Rule 26.
 5.2 The start will be on the committee vessel line as described in Section 6.13.6 General Conditions of Racing for Junior & Youth Fleets.

6. The Finish

- 6.1 The finish will be on the committee vessel line as described in Section 6.13.7 General Conditions of Racing for Junior & Youth Fleets.

7. Time Limits

- 7.1 The time limit for each race shall be 90 minutes or shorter at the discretion of the Race Committee.

8. Scoring

- 8.1 The number of races scheduled for the series is shown in Section 5.8 MYC Calendar.
 8.2 The number of races required to constitute a series will be 4 less than the number of races scheduled in the series.
 8.3 Each boat's series score will be the total of her race scores, with her worst 2 scores discarded.

9. PHS Handicaps

- 9.1 The Handicap (HC) assigned to a Junior for the Performance Handicapping System (PHS) is a 4-decimal number. The elapsed time will be multiplied by HC to get a corrected time.
- 9.2 After each race, a Race Time Correction Factor (TCF) will be computed for each boat such that if each boat's Race TCF was applied to its elapsed time for that race, all boats would have finished at the same corrected time as the reference boat. The reference boat is usually the boat that finishes about 40% of the way through the fleet on elapsed time. If a boat fails to finish, no TCF is calculated. For each competitor, the Race TCF = Reference Time / Competitor's Elapsed Time.
- 9.3 The Race TCF will have an upper and a lower clamp of 5% when compared to its previous TCF.
- 9.4 The Handicaps are adjusted as follows:
 - Race 1 will be set by the Race Director after considering previous TCFs and any advice from Instructors.
 - Race 2 will be the average of the HC for Race 1 and the TCF for Race 1.
 - Race 3 will be the average of the HC for Race 1 and the TCFs for Races 1 and 2.
 - Race 4 will be the average of the TCFs for Races 1, 2 and 3.
 - A boat's HC for a subsequent race will be the average of the last four TCFs.

PITTWATER ECO ADVENTURES

**ADVENTURE.
CONSERVATION.
COMMUNITY.**

- Beach Cleanup
- Plastic Recycling
- Bush Regeneration
- Tree Planting
- Cultural Education
- Duke of Edinburgh
- School Camps
- Corporate Volunteering
- Community Events

0436 808 528

PITTWATERECOADVENTURES@GMAIL.COM

**HANDS-ON CONSERVATION
WORKSHOPS AND
EDUCATIONAL PROGRAMS**

PLAN YOUR NEXT SCHOOL OR
CORPORATE ACTIVITY
& MAKE AN IMPACT







9948 3162

The Hart family
have been servicing the Manly area
for almost 100 years.

Graham Hart and his team
survived the blaze and continue
to provide value for automotive
servicing and repair, tyres,
and
now MARINE battery
system design and supply.



9948 3162

JUNIOR & YOUTH MINI REGATTA – NOR

1. Rules

- 1.1 The racing will be governed by the rules as defined in the Racing Rules of Sailing (RRS) and Section 6.13 General Conditions of Racing for Junior Fleets as defined by of the MYC Handbook, and any applicable class/association rules, except as altered by the Sailing Instructions which are also considered part of the rules.
- 1.2 The Organising Authority may amend this Notice of Race. Amendments made prior to the race day will be posted on WhatsApp and displayed on the Notice Board located on the ground floor of MYC. Amendments thereafter shall be published on the Notice Board located on the ground floor of MYC prior to the pre-race briefing.

2. Eligibility and Entry

- 2.1 Racing is open to Junior classes:
 - O'pen Skiff
 - ILCA 4
 - ILCA 6
- 2.2 Boats must hold a current 'Off the Beach' Boat Registration and Compliance Declaration.
- 2.3 A class must be constituted by a minimum of 3 boats.

3. Fees

- 3.1 There is no entry fee for junior classes.

4. Schedule

- 4.1 The schedule of race days is shown in Section 5.8 MYC Calendar.
- 4.2 All races are Scratch Races.

5. Racing Area

- 5.1 Racing will be conducted in North Harbour and Manly Cove.

JUNIOR & YOUTH MINI REGATTA – SI

1. Rules

- 1.1 The racing will be governed by the rules as defined in the Racing Rules of Sailing (RRS) and Section 6.13 General Conditions of Racing for Junior Fleets as defined by of the MYC Handbook, and any applicable class/association rules, except as altered by the Sailing Instructions which are also considered part of the rules.

2. Schedule of Races

- 2.1 The schedule of race days is shown in Section 5.8 MYC Calendar.
 2.2 There are up to six races scheduled for each day.
 2.3 All Races are Scratch Races.
 2.4 There will be a pre-race briefing on the MYC Rigging deck at 1250 hrs.
 2.5 The classes to be sailed will be announced at the pre-race briefing.
 2.6 The scheduled time of the warning signal for the earliest race is 1420 hrs.
 2.7 The order of the classes/divisions to be sailed will be announced during the pre-race briefing.
 2.8 When more than one race will be held on the same day, the warning signal for each succeeding race will be made as soon as practicable after the finish of the previous race.

3. Class Flags

- 3.1 The class flags will be as follows:

CLASS	FLAG
O'pen Skiff	O'pen Skiff class flag
ILCA 4	Green flag with a Red Laser emblem
ILCA 6	Green flag with a Red Laser emblem

4. The Courses

- 4.1 Courses 3 or 4 from Appendix 12.A1 will be used.

5. The Start

- 5.1 Races will be started by using RRS Rule 26.
 5.2 The start will be on the committee vessel line as described in Section 6.13.6 General Conditions of Racing for Junior & Youth Fleets.

6. The Finish

- 6.1 The finish will be on the committee vessel line as described in Section 6.13.7 General Conditions of Racing for Junior & Youth Fleets.

7. Time Limits

- 7.1 The time limit for each race is 60 minutes or shorter at the discretion of the Race Committee.

8. Scoring

- 8.1 A boat's series score will be the total of her race scores, with no scores discarded.
 8.2 The number of races required to constitute a series is 3.

JUNIOR & YOUTH DESTINATION RACE – NOR

1. Rules

- 1.1 The racing will be governed by the rules as defined in the Racing Rules of Sailing (RRS) and Section 6.13 General Conditions of Racing for Junior Fleets as defined by of the MYC Handbook, and any applicable class/association rules, except as altered by the Sailing Instructions which are also considered part of the rules.
- 1.2 The Organising Authority may amend this Notice of Race. Amendments made prior to the race day will be posted on WhatsApp and displayed on the Notice Board located on the ground floor of MYC. Amendments thereafter shall be published on the Notice Board located on the ground floor of MYC prior to the pre-race briefing.

2. Eligibility and Entry

- 2.1 Racing is open to the following classes:
 - O'pen Skiff
 - ILCA 4
 - ILCA 6
- 2.2 Boats must hold a current 'Off the Beach' Boat Registration and Compliance Declaration.
- 2.3 A class must be constituted by a minimum of 3 boats.

3. Fees

- 3.1 There is no entry fee for junior classes.

4. Schedule

- 4.1 The schedule of race days is shown in Section 5.8 MYC Calendar.
- 4.2 All races are Scratch Start Handicap Races.

5. Racing Area

- 5.1 Racing will be conducted in North Harbour, Manly Cove and Balmoral.

JUNIOR & YOUTH DESTINATION RACE – SI

1. Rules

- 1.1 The racing will be governed by the rules as defined in the Racing Rules of Sailing (RRS) and Section 6.13 General Conditions of Racing for Junior Fleets as defined by of the MYC Handbook, and any applicable class/association rules, except as altered by the Sailing Instructions which are also considered part of the rules.

2. Schedule of Races

- 2.1 The schedule of race days is shown in Section 5.8 MYC Calendar.
 2.2 All races are Scratch Start Handicap Races.
 2.3 There will be a pre-race briefing on the MYC Rigging deck at 1250 hrs.
 2.4 The classes to be sailed will be announced at the pre-race briefing.
 2.5 The scheduled time of the warning signal for the earliest race is 1420 hrs.
 2.6 The order of the classes/divisions to be sailed will be announced during the pre-race briefing.

3. Class Flags

- 3.1 The class flags will be as follows:

CLASS	FLAG
O'pen Skiff	O'pen Skiff class flag
ILCA 4	Green flag with a Red Laser emblem
ILCA 6	Green flag with a Red Laser emblem

4. The Courses

- 4.1 Courses will be determined on the day and illustrated at the briefing.

5. The Start

- 5.1 Races will be started by using RRS Rule 26.
 5.2 The start will be on the Committee Boat line as described in Section 6.13.6 General Conditions of Racing for Junior & Youth Fleets.

6. The Finish

- 6.1 The finish will be on the Committee Boat line as described in Section 6.13.7 General Conditions of Racing for Junior & Youth Fleets.

7. Time Limits

- 7.1 The time limit for each race shall be **180 minutes** or shorter at the discretion of the Race Committee.

8. Scoring

- 8.1 The number of races scheduled for the series is shown in Section 5.8 MYC Calendar.
 8.2 A boat's series score will be the total of her race scores, with no scores discarded.
 8.3 The number of races required to constitute a series will be 1.

9. PHS Handicaps

- 9.1 The Handicaps from the most recent Handicap Point Score Race will be used.

10. ILCA NOR & SI

ILCA MICRO REGATTA – NOR

1. Rules

- 1.1 The racing will be governed by the rules as defined in the Racing Rules of Sailing (RRS) and the General Conditions of Racing as defined by Section 7 of the MYC Handbook and the rules and by-laws of the International ILCA Class, except as altered by the Sailing Instructions which are also considered part of the rules.
- 1.2 The Organising Authority may amend this Notice of Race. Amendments will be published on the Official Notice Board on the MYC website www.myc.org.au .

2. Eligibility and Entry

- 2.1 The racing is open to the following classes:
 - ILCA 7
 - ILCA 6
 - ILCA 4
- 2.2 ILCAs must hold an 'Off the Beach' Boat Registration and Compliance form.
- 2.3 A fleet must be constituted by a minimum of five ILCAs.

3. Fees

- 3.1 Entry fees are listed in Section 5.1 Racing Fees in the MYC Handbook.
- 3.2 The casual entry fee is for all the races scheduled on one race day.
- 3.3 There is no entry fee for junior classes.

4. Schedule

- 4.1 The schedule of race days is shown in Section 5.8 MYC Calendar.
- 4.2 There are 4 short Scratch Start Handicap Races (Sprints) scheduled per race day plus Team results for each day's racing.
- 4.3 The following classes will be sailed:
 - ILCA 7
 - ILCA 6
 - ILCA 4
- 4.4 ILCAs may only compete with the nominated helm.

5. Racing Area

- 5.1 Racing will be conducted in Manly Cove, North Harbour and Spring Cove in Sydney Harbour.

6. Further Information

- 6.1 A BBQ, presentation and get together will be held on the deck of MYC after racing.

ILCA MICRO REGATTA – SI

1. Rules

1.1 The racing will be governed by the rules as defined in the Racing Rules of Sailing (RRS) and by the General Conditions of Racing as defined by Section 7 of the MYC Handbook and the rules and by-laws of the International ILCA Class Association, except as altered by the Sailing Instructions which are also considered part of the rules.

2. Schedule of Races

2.1 The schedule of race days is shown in Section 5.8 MYC Calendar.

2.2 There are 4 short Scratch Start Handicap Races (Sprints) scheduled per race day plus Team results for each day's racing.

2.3 The following classes will be sailed:

- ILCA 7
- ILCA 6
- ILCA 4

2.4 ILCAs may only compete with the nominated helm.

2.5 The Warning Signal for the first race of each day is as soon as practicable after 1400 hours.

2.6 The warning signal for the second, third and fourth race of each day will be made as soon as practicable after the completion of the preceding race.

3. Fleets and Class Flags

3.1 The ILCA 7, ILCA 6 and ILCA 4 division will sail as one fleet.

3.2 The Class flags will be as follows:

FLEET / CLASS	CLASS FLAG
ILCA 7, ILCA 6, ILCA 4	White flag with a Red Laser emblem

4. The Courses

4.1 Courses are as shown in Appendix 12.A2.

4.2 The course number will be displayed on the Committee Boat before the start.

5. Marks

5.1 Marks 1S and 1P will be inflatable buoys.

5.2 Marks 2S and 2P will be inflatable buoys.

6. The Start

6.1 The start will be from the Committee Boat line as described in Sections 7.10 and 7.12 General Conditions of Racing.

7. The Finish

7.1 The finish will be on the Committee Boat line as described in Section 7.14 General Conditions of Racing.

8. Time Limits

8.1 The time limit for the first boat to complete the course and finish correctly in each fleet race will be 30 minutes.

8.2 Boats failing to finish within 10 minutes after the first boat which sails the course and finishes, will be scored Did Not Finish without a hearing. This changes RRS Rule 35, RRS A4 and RRS A5.

9. Penalty System

9.1 The racing rules will be modified in accordance with RRS Rule 86 as follows: RRS Rule 44.1 and RRS Rule 44.2 are changed so that only one turn, including one tack and one gybe, is required. This changes Section 7.18 Penalty System in General Conditions of Racing.

10. Protests and Requests for Redress

- 10.1 Protests shall be written on forms available at the MYC Office and delivered there within 2 hours after the time of the last boat's finish.
- 10.2 Protests will be heard in approximately the order of receipt as soon as possible.
- 10.3 Protest notices will be posted within 30 minutes of the protest time limit to inform competitors where and when there is a hearing in which they are parties or named as witnesses.

11. Scoring

- 11.1 A boat's series score will be the total of her race scores, other than allowed discards.
- 11.2 The number of races required to constitute a series is 8 completed races.
- 11.3 When 17 or more races are completed, the 4 worst scores will be discarded.
- 11.4 When 13 to 16 races are completed, the 3 worst scores will be discarded.
- 11.5 When 10 to 12 races are completed, the 2 worst scores will be discarded.
- 11.6 When 8 to 9 races are completed, the worst score will be discarded.

12. Prizes

- 12.1 Prizes will be awarded on the deck at the end of the day's racing. All prizes not immediately accepted by competitors or their representatives will be redrawn.
- 12.2 Perpetual trophies awarded by MYC are shown in Section 5.9, Trophies and Presentations.



ILCA CHAMPIONSHIP & POINT SCORES – NOR

1. Rules

- 1.1 The racing will be governed by the rules as defined in the Racing Rules of Sailing (RRS) and the General Conditions of Racing as defined by Section 7 of the MYC Handbook and the rules and by-laws of the International ILCA Class Association, except as altered by the Sailing Instructions which are also considered part of the rules.
- 1.2 The Organising Authority may amend this Notice of Race. Amendments will be published on the Official Notice Board on the MYC website www.myc.org.au.

2. Eligibility and Entry

- 2.1 The racing is open to the following classes:
 - ILCA 7
 - ILCA 6
 - ILCA 4
- 2.2 ILCAs must hold an 'Off the Beach' Boat Registration and Compliance form.
- 2.3 A fleet must be constituted by a minimum of five ILCAs.

3. Fees

- 3.1 Entry fees are listed in Section 5.1, Racing Fees in the MYC Handbook.
- 3.2 The casual entry fee is for all the races scheduled on one race day.

4. Schedule

- 4.1 The schedule of races is shown in Section 5.8 MYC Calendar.
- 4.2 There are 2 races scheduled per race day. Courses will be chosen with a target time of 35 minutes for each race. Pursuit Races are indicated by (*); the other races are Scratch Starts.
- 4.3 Each race may be scored as part of one or more Series:
 - Club Championship (CC)
 - 4P Championship (4P)
 - Spring Point Score (SP)
 - Autumn Point Score (AP)
 - Annual Point Score (SP + AP)
- 4.4 The following classes will be sailed:
 - ILCA 7
 - ILCA 6
 - ILCA 4
- 4.5 ILCAs may only compete in a Series with the nominated helm.

5. Racing Area

- 5.1 Racing will be conducted in Manly Cove, North Harbour and Spring Cove in Sydney Harbour.

6. Further Information

- 6.1 A BBQ, presentation and get together will be held on the deck of MYC after racing.



PEPPER TREE WINES

ILCA CHAMPIONSHIP & POINT SCORES – SI

1. Rules

- 1.1 The racing will be governed by the rules as defined in the Racing Rules of Sailing (RRS) and the General Conditions of Racing as defined by Section 7 of the MYC Handbook and the rules and by-laws of the International ILCA Class Association, except as altered by the Sailing Instructions which are also considered part of the rules.

2. Schedule of Races

- 2.1 The schedule of races is shown in Section 5.8 MYC Calendar.
- 2.2 There are 2 races scheduled per race day. Pursuit Races are indicated by a (*); the other races are Scratch Starts.
- 2.3 Each race may be scored as part of one or more Series:
- Club Championship (CC)
 - 4P Championship (4P)
 - Spring Point Score (SP)
 - Autumn Point Score (AP)
 - Annual Point Score (SP + AP)
- 2.4 The following classes will be sailed:
- ILCA 7
 - ILCA 6
 - ILCA 4
- 2.5 ILCAs may only compete in a Series with the nominated helm.
- 2.6 The earliest start time for Pursuit Races will not be before 1400 hours for all classes.
- 2.7 The warning signal for Scratch Starts will be made as soon as practicable after the completion of the preceding race.
- 2.8 When classes are racing separately, the order of the Scratch Starts will be determined by the Race Officer and indicated by the class flags. The warning signal for a subsequent start will be no sooner than 5 minutes after the previous start signal.

3. Fleets and Class Flags

- 3.1 The ILCA 7 and ILCA 6 class will sail as one fleet.
- 3.2 The ILCA 4 class will sail as one fleet, providing there are more than five entries. Otherwise they will sail with the ILCA 6 & ILCA 7 fleet.
- 3.3 The Class flags will be as follows:

FLEET / CLASS	CLASS FLAG
ILCA 7, ILCA 6	White flag with a Red Laser emblem
ILCA 4	Green flag with a Red Laser emblem

4. The Courses

- 4.1 Courses are as shown in Appendix 12.A2.
- 4.2 Courses 1 to 3 are Windward - Leeward Courses for the Club Championship race days.
- 4.3 Courses 4 to 7 are Harry Anderson Courses for the 4P race days.
- 4.4 Courses 8 and 9 are Figure 8 courses for the Club Championship race days.
- 4.5 The course number will be displayed on the committee boat before the start.

5. Marks

- 5.1 Mark 1S and 1P will be inflatable buoys.
- 5.2 Marks 2S, 2P, 3S, 3P, 4S and 4P will be inflatable buoys.

6. The Start

- 6.1 Scratch Starts will be on the Committee Boat line as described in Sections 7.10 and 7.12 General Conditions of Racing.
- 6.2 For Pursuit races, a signal sequence as described in RRS Rule 26 shall be used (5,4,1,0 count down sequence) to indicate the Earliest Start Time. Each boat's Warning, Preparatory and Start Signals shall be taken from the displayed signal plus their allocated start handicap. There are no recalls and RRS Rule 29 (Recall Signals) does not apply.

6.3 Boats whose Warning Signal has not been made shall avoid the starting area and keep clear of boats whose Warning Signal has been made, when reasonable to do so.

7. The Finish

7.1 The finish will be on the Committee Boat line as described in Section 7.14 General Conditions of Racing.

8. Time Limits

8.1 The time limit for the first boat to complete the course and finish correctly in each fleet will be 70 minutes.

8.2 Boats failing to finish within 25 minutes after the first boat of the same fleet which sails the course and finishes, will be scored Did Not Finish without a hearing. This changes RRS Rule 35, RRS A4 and RRS A5.

9. Penalty System

9.1 Your attention is drawn to RRS Rule 44.1 and RRS Rule 44.2. RRS Rule 44.2 states in part that ‘a boat takes a One-Turn or Two-Turns Penalty promptly by making the required turns in the same direction, each including one tack and one gybe’.

10. Protests and Requests for Redress

10.1 Protests shall be written on forms available at the MYC Office and delivered there within 2 hours after the time of the last boat’s finish.

10.2 Protests will be heard in approximately the order of receipt as soon as possible.

10.3 Protest notices will be posted within 30 minutes of the protest time limit to inform competitors where and when there is a hearing in which they are parties or named as witnesses.

11. Scoring

11.1 A boat’s score in each Series will be the total of each applicable race, other than allowed discards.

11.2 CC races will score using a boat’s elapsed time modified by the class yardstick.

11.3 4P races with scratch starts will score using a boat’s elapsed time modified by the class yardstick.

11.4 4P races with pursuit starts (designated by * in Section 5.8 MYC Calendar) will score using a boat’s elapsed time adjusted by the pursuit time, then modified by the class yardstick.

11.5 Point score races with scratch starts will score using a boat’s elapsed time modified by the handicap TCF.

11.6 The number of races required to constitute a series is 10 completed races.

11.7 When 13 or more races are completed in a Series, the 3 worst scores will be discarded.

11.8 When 10 to 12 races are completed in a Series, the 2 worst scores will be discarded.

11.9 CC and 4P racing conducted before December 31 will count towards the SP series points

11.10 CC and 4P racing conducted after December 31 will count towards the AP series points.

11.11 The Annual Point Score will be the combination of the net points from the SP and AP series.

11.12 Australian Yardstick will be set by the Race Committee and will not be subject to request for redress.

11.13 Pursuit start times and TCFs will be adjusted after each race as follows based on the Handicap results.

FIRST Sixth	SECOND Sixth	2nd LAST Sixth	LAST Sixth
+ 4%	+ 2%	- 2%	- 4%

12. Prizes

12.1 Prizes will be awarded on the deck at the end of the day’s racing. All prizes not immediately accepted by competitors or their representatives will be redrawn.

12.2 Perpetual trophies awarded by MYC are shown in Section 5.9, Trophies and Presentations.



Life is better when you surf.

**Surfboards | Softboards
Paddleboards | Surf Accessories**
SAVE 25-35%

**Global Surf Industries
Factory Outlet**

2/20 William St
Brookvale, NSW 2100
Toll free: 1 300 857 791

OPENING HOURS

Mon - Fri: 10am - 4pm

Sat: 9am - 12 noon

Sunday: closed

11. YACHT NOR & SI

YACHT CHRISTMAS – NOR

Invitation

The Christmas race is a fun non-spinnaker race where rules are optional. Hop on a boat or just come back for the party at 1pm.

1. Rules

- 1.1 The racing will be governed by the rules as defined in the Racing Rules of Sailing (RRS) and the General Conditions of Racing as defined by Section 7 of the MYC Handbook, except as altered by the Sailing Instructions which are also considered part of the rules.
- 1.2 The Organising Authority may amend this Notice of Race. Amendments will be published on the Official Notice Board on the MYC website www.myc.org.au.

2. Eligibility and Entry

- 2.1 Entry is open to mono hull sailing yachts with length overall from 6m to 20m or at the Race Committee's discretion.
- 2.2 Yachts must hold a Category 7 AS Equipment Audit Form.

3. Fees

- 3.1 The Christmas Race is free entry.

4. Schedule

- 4.1 The schedule of race days is shown in Section 5.8 MYC Calendar.
- 4.2 The following classes will be sailed:
 - Yachts – Non-Spinnaker
- 4.3 There is 1 Pursuit Race scheduled for each day.

5. Racing Area

- 5.1 Racing will be conducted within Sydney Harbour.

6. Further Information

- 6.1 A BBQ, presentation and get together will be held on the deck of MYC after racing.

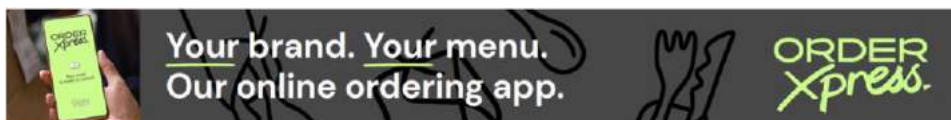

Your brand. Your menu.
Our online ordering app.

ORDER Xpress.

[Book a Demo](#) | 9451 0901 | orderxpress.com.au | Unit 14 Bldg 7/49 Frenchs Forest Rd E, Frenchs Forest NSW 2086

YACHT CHRISTMAS – SI

1. Rules

- 1.1 The racing will be governed by the rules as defined in the Racing Rules of Sailing (RRS) and the General Conditions of Racing as defined by Section 7 of the MYC Handbook, except as altered by the Sailing Instructions which are also considered part of the rules.

2. Schedule of Races

- 2.1 The schedule of race days is shown in Section 5.8 MYC Calendar.
 2.2 The following classes will be sailed:
- Yachts – Non-Spinnaker
- 2.3 There is 1 Pursuit Race scheduled for each day.
 2.4 The earliest start for the first boat will be 1100 hrs.

3. Course

- 3.1 The course for yachts is shown as follows. All marks to starboard unless otherwise indicated.

1.	Start Manly (triangles)	6.	Manly West AS
2.	Cannae Point AS	7.	Manly East AS
3.	Rocky Point AS	8.	Cannae Point AS
4.	Edwards Beach AS	9.	Finish Manly (triangles)
5.	Grotto Point AS		

4. The Start

- 4.1 All races will be Pursuit starts from the clubhouse triangles as described in Sections 7.11 and 7.13 General Conditions of Racing.

5. The Finish

- 5.1 The finish will be on the clubhouse triangles as described in Section 7.15 General Conditions of Racing.

6. Time Limits

- 6.1 The time limit will be 1400 hours.

7. Further Information

- 7.1 A BBQ and presentation will be held at the MYC clubhouse after racing.

The
best of
four
worlds.

MANLY
YACHT CLUB
SPECIAL

Varietal Range
Mixed or Straight
Dozen | \$199

PEPPERTREE
Cabernet Sauvignon
South Australia

PEPPERTREE
Merlot
South Australia

PEPPERTREE
Shiraz
South Australia

PEPPERTREE
Chardonnay
South Australia

PEPPERTREE
WINES

peppertreewines.com.au

YACHT CLUB CHAMPIONSHIP – NOR

Invitation

The Club Championships are the premiere series at Manly Yacht Club. The series comprises 10 scratch start races around the sound, including 5 of the Combined Clubs Sunday Series races. See if you can sail to your handicap and become the season Club Champion. Also race for the coveted Bob Greene Trophy or the Davis Cup by being the fastest boat around the course in your division.

1. Rules

- 1.1 The racing will be governed by the rules as defined in the current Racing Rules of Sailing (RRS) and any General Conditions of Racing as defined by the Organising Authority, except as altered by the Sailing Instructions which are also considered part of the rules.
- 1.2 The Organising Authority (OA) for this series is Manly Yacht Club (MYC).
- 1.3 Races from the Combined Clubs Sunday Series are included in this series, which may have a different Organising Authority for the purpose of conducting those races.
- 1.4 The Sailing Instructions will be those of the Combined Clubs Sunday Series, other than as modified by this NOR.
- 1.5 MYC may amend this Notice of Race. Amendments will be published on the Official Notice Board on the MYC website www.myc.org.au

2. Eligibility and Entry

- 2.1 A division must be constituted by a minimum of four yachts.
- 2.2 Yachts may only compete in the Club Championships using the nominated helm(s). Written notice of changes to helm may be considered by the Race Director.

3. Fees

- 3.1 Entry fees are listed in Section 5.1, Racing Fees in the MYC Handbook.
- 3.2 The entry fee includes the Manly Sprint Series and all Combined Club Sunday Series races, even those not included in this point score.

4. Schedule

- 4.1 The schedule of race days is shown in Section 5.8 MYC Calendar.
- 4.2 There is 1 TCF Race scheduled for each division per day.
- 4.3 For information, races 1, 3, 5, 9 and 10 of this series will be the same as Combined Clubs Sunday Series passage races 1, 5, 6, 10 & 11.

5. Divisions and Handicaps

- 5.1 The following divisions will be sailed:
 - Yachts - Division 1 for yachts with spinnaker and PHS handicap.
 - Yachts - Division 2 for yachts with and without spinnaker and PHS handicap.

6. Scoring

- 6.1 The PHS Handicap system will be used to score a boat's result and adjust her handicap.
- 6.2 The number of races scheduled for the series is shown in Section 5.8 MYC Calendar.
- 6.3 The number of races required to constitute a series will be 4 less than the number of races scheduled in the series
- 6.4 When 10 races have been completed, a boat's series score will be the total of her series scores excluding her worst 2 scores.
- 6.5 When fewer than 10 races have been completed, a boat's series score will be the total of her series scores excluding her worst 1 score.

7. Prizes

- 7.1 Prizes will be awarded on the deck at the end of the day's racing. All prizes not immediately accepted by competitors or their representatives will be redrawn.
- 7.2 Grand Prizes, where applicable, will be drawn from the "barrel" on the last day of racing in the series.

8. Further Information

- 8.1 A BBQ, presentation and get together will be held on the MYC balcony after racing.



altitude
THE LODGE SMIGGINS

If you're looking for an "experience" in the snow, then Altitude is the place for you.

- Ski lifts almost on your doorstep
- Gourmet dinner and full breakfast
- Ensuite rooms to suit couples and families
- Spa and sauna
- Bar

For enquiries and bookings, contact Phil on 1800 610 348 or reservations@altitudelodge.com.au and mention the Manly Yacht Club for a special price!

The advertisement includes a large image of the lodge's exterior at dusk, featuring a large tree and a building with warm lighting. Two smaller inset images show the interior: one of a lounge area with a fireplace and another of a bedroom with a red bedspread.

COMBINED CLUBS SUNDAY SERIES



Notice of Race and Sailing Instructions

The Organising Authority (OA) is Manly Yacht Club (MYC) and Middle Harbour Yacht Club (MHYC)

An invitation is extended to eligible boats to participate in the Combine Clubs Sunday Series (CCSS) Category 7 inshore racing competition conducted in and around The Sound of Sydney Harbour under PHS, IRC and ORC handicaps.

Eleven races will be conducted over seven summer Sundays for the combined fleets of Manly Yacht Club (MYC), Middle Harbour Yacht Club (MHYC) and others. This includes two sprint days with multiple windward leeward races.

Races of the CCSS may be included in other point score series of MYC and MHYC.

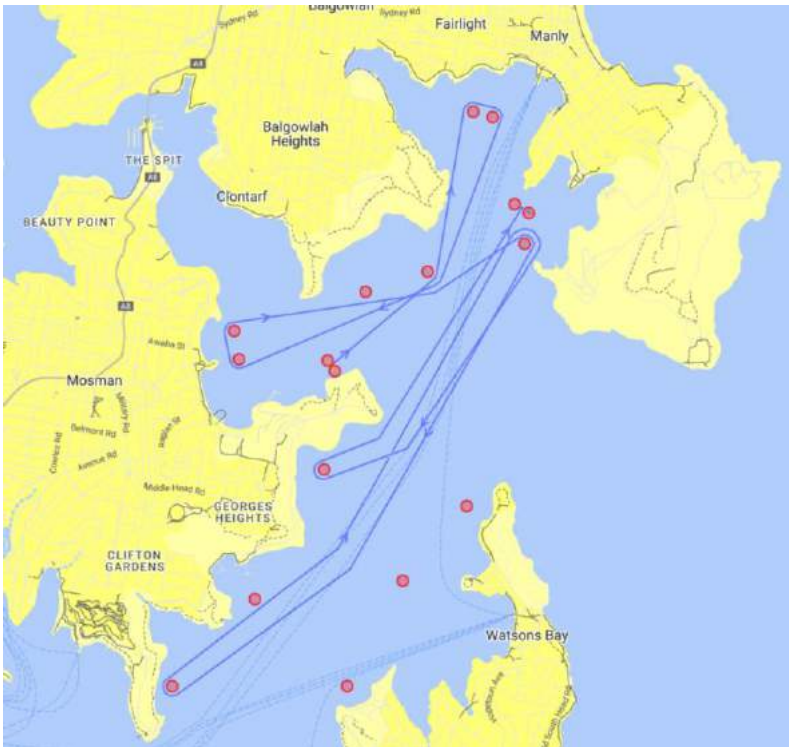

An indicative course in the Race Area

1. Rules

- 1.1 The racing will be governed by the rules as defined in the current Racing Rules of Sailing (RRS) and any General Conditions of Racing or Season Notice of Race as defined by the Organising Authority, except as altered by these Sailing Instructions.
- 1.2 This document is the Notice of Race and Sailing Instructions required by RRS 89.2 and 90.2.
- 1.3 The attention of competitors is drawn to the responsibilities of owners and skippers as detailed in the By-Laws, Risk Warning, Competitor Declaration, Disclaimer of Liability and/or Safety Requirements of the Organising Club by which they enter this series.
- 1.4 In the event of conflict between any of the rules or regulations, other than RRS, the sailing instructions will prevail. This changes RRS 63.7.
- 1.5 In the event of conflict between any of the rules in the General Conditions of Racing or Season Notice of Race of an Organising Club, then the rules of the club through which the boat is entered will prevail.
- 1.6 RRS 51 is amended so that boats with movable or variable ballast (within the meaning of those terms in the Special Regulations) may move that ballast for the purpose of changing trim or stability.
- 1.7 RRS 52 is amended so that electric winches and canting keels maybe adjusted using the boat's electrical system.
- 1.8 IRC Rule 22.4.2 and ORC Rule 200.1 shall not apply.
- 1.9 Competitors shall comply with all applicable regulations of: Transport for NSW (TfNSW); traffic directions of NSW Boating Safety Officers (BSOs) and NSW Port Authority.
- 1.10 The notation '[DP]' in a rule means that the penalty for a breach of that rule may, at the discretion of the protest committee, be less than disqualification. A boat that has broken such a rule, must provide a declaration to the Race Committee within the time limits set for protests.
- 1.11 The notation '[NP]' in a rule means that a boat may not protest another boat for breaking that rule. This changes RRS 60.1(a).
- 1.12 The Organising Authority may amend this Notice of Race and Sailing Instructions.

2. Eligibility

- 2.1 The series is open to self-righting single hull displacement yachts.
- 2.2 The helmsperson nominated on the entry system shall be deemed to be the person in charge of the boat.
- 2.3 No boat shall start unless there is a minimum of two (2) persons on board.
- 2.4 [DP] [NP] All competitors helming, or crewing shall conform to RRS 46 and the Australian Sailing Prescriptions. Any person who is not a financial member of an AS recognised yacht club must apply and receive a Sail Pass before racing to comply with RRS 46.
- 2.5 [DP] All boats shall have a valid Australian Sailing (AS) Special Regulations Category 7, or higher, Equipment Audit Form. Random equipment audits may be made throughout the season. Any boat failing to comply with equipment requirements may be subject to protest by the race committee.

3. Entry

- 3.1 Eligible boats may enter via their respective Organising Club's online entry process.
- 3.2 Boats from clubs other than an Organising Club may choose to enter through either of the Organising Club's online entry process.

4. Entry Fees

- 4.1 Entry fees are according to the respective Organising Club's fee schedule.
- 4.2 Entry fees for boats from clubs other than an Organising Club will be according to the Organising Club by which they choose to enter.

5. Schedule of Races

5.1 The schedule of racing is:

DATE	RACES	FIRST WARNING SIGNAL	DUTY CLUB
8 Sep 2024	1	1250 hrs	MYC
13 Oct 2024	2, 3, 4 (Sprints)	1150 hrs	MHYC
20 Oct 2024	5	1250 hrs	MYC
17 Nov 2024	6	1250 hrs	MHYC
16 Feb 2025	7, 8, 9 (Sprints)	1150 hrs	MYC
9 Mar 2025	10	1250 hrs	MHYC
13 Apr 2025	11	1250 hrs	MYC

6. Divisions and Handicaps

6.1 The following divisions are intended to be sailed:

- Division 1 for yachts with spinnaker scored on PHS, IRC and ORC.
- Division 2 for yachts with or without spinnaker scored on PHS and ORC .

6.2 [NP] Entries will be allocated into divisions at the Organising Authority's absolute discretion and such determination will not be grounds for protest or redress.

6.3 [NP] The Organising Authority, at its discretion, may choose to add or delete divisions depending on entry numbers.

6.4 All entries will be allocated a Performance Handicap System (PHS) handicap that applies a Time Correction Factor (TCF) to a boat's elapsed time. Handicaps may be adjusted after each race has been finalised.

6.5 Boats with a valid IRC Standard or IRC Endorsed certificate may be scored in the IRC point score, which will be based on the application of the IRC Time Correction Calculation (TCC) as displayed on the boat's certificate.

6.6 Boats with a valid ORC International or ORC Club certificate may be scored in the ORC point score. The following ORC Ratings will be applied:

- a) For the Sprint Races - Single Number Time on Time Windward/Leeward
- b) For the Passage Races - Single Number Time on Time All Purpose.

6.7 Non-spinnaker entrants are not permitted to fly spinnakers. Headsails may be poled out but must be tacked to the foot of the forestay and fully hanked or attached to the forestay by a luff groove device. The forestay is as defined in the current World Sailing Equipment Rules of Sailing. Couta boats or similar craft are exempted from this provision where the forestay is integrated in the headsail luff. Spinnaker entrants may choose to not fly spinnakers.

7. Start Times and Flags

- 7.1 Races will be started using RRS 26 with the warning signal made 5 minutes before the starting signal.
- 7.2 For passage races (1, 5, 6, 10 & 11) the scheduled time of the warning signal for each class or division is shown below. Races will be started no earlier than times shown. Times shall be taken from visual signals; the absence or mistiming of a sound signal shall be disregarded.

WARNING	CLASS/DIVISION	FLAG
1250 hrs	Yachts - Division 1	Code Flag D
1255 hrs	Yachts - Division 2	Code Flag E

- 7.3 For sprint races (2, 3, 4, 7, 8 & 9) the scheduled time of the first warning signal for each class or division is shown below. Races will be started no earlier than times shown. Times shall be taken from visual signals; the absence or mistiming of a sound signal shall be disregarded.

WARNING	CLASS/DIVISION	FLAG
1150 hrs	Yachts - Division 1	Code Flag D
1155 hrs	Yachts - Division 2	Code Flag E

8. Communication with Competitors

- 8.1 Notices to competitors will be posted on the official notice boards of the Organising Clubs (which may be online). Notices may also be posted to the Sailsys Series Noticeboard.
- 8.2 The race committee intends to monitor VHF channel 72 and will use the radio to advise competitors of race information.
- 8.3 [DP] Boats that retire from a race before finishing are required to notify the race committee on VHF channel 72, or by phoning the Organising Club on duty for the day.

9. Signals Made Ashore

- 9.1 Signals made ashore will be displayed at the Organising Clubs on their flag masts.
- 9.2 When flag AP is displayed ashore, '1 minute' is replaced with 'not less than 30 minutes' in Race Signals AP.

10. Racing Area

- 10.1 Racing will be conducted within The Sound and surrounding inshore waters of Sydney Harbour.

11. Mark and Courses

- 11.1 The course to be sailed will be indicated by the appropriate numeral board displayed on the committee vessel.
- 11.2 The courses to be sailed are listed in both the MYC and MHYC handbooks
- 11.3 Courses in the **MYC Handbook**
- Division 1 passage races are shown in Appendix 12.A3.
 - Division 2 passage races are shown in Appendix 12.A4.
 - Courses for sprint races are shown in Appendix 12.A10.
 - Fixed and laid marks are described on the chart in the inside back flap.
- 11.4 Courses in the **MHYC Handbook**
- Courses are described in Attachment A.
 - Laid Marks for Sprint Races are described in Attachment B.
 - Fixed Harbour Marks are described in Appendix 1.
- 11.5 Australian Sailing (AS) marks are permanent laid yellow spar buoys. All other marks are inflatable marks from the Organising Club.
- 11.6 The Quarantine Head mark is a laid inflatable mark in the vicinity (500m) of Quarantine Head.

12. The Start

- 12.1 The committee vessel will be identified by the burgee of an Organising Club.
- 12.2 The starting line will be between the staff or halyard displaying an orange flag on the committee vessel and the course side of an inflatable buoy.
- 12.3 [NP] To assist competitors, the race committee may advise individual and general recalls over VHF 72. This changes RRS 29.1 and 29.2.

13. The Finish

- 13.1 The committee vessel will be identified by the burgee of an Organising Club and may be a different vessel than that which started the race.
- 13.2 The finishing line will be between the staff or halyard displaying a blue flag on the committee vessel and a yellow inflatable buoy which may be at either end of the line.
- 13.3 The committee vessel may lay multiple lines at the same time for other classes or series. Competitors are reminded that RRS 23.1 (Interfering with another boat) applies to all competitors regardless of which line they are racing to.

14. Time Limits

- 14.1 Subject to 14.2 and 14.3, the time limit for yachts shall be 1700 hours.
- 14.2 If a race is postponed for any reason the time limit will be extended by the length of the postponement or for 30 minutes whichever is the less.
- 14.3 If the first boat in a division finishes within 30 minutes of the time limit, then the time limit shall be extended by 30 minutes from the finishing time of the first boat for that division or to 1730 hours whichever is sooner.
- 14.4 If one boat finishes within the time limit, all boats that have started and not finished by the time limit will be scored DNF. This changes RRS 35.

15. Shortened Course

- 15.1 In the event of the course being shortened before the start, flag S will be displayed with the course signal with two sound signals. Boats are to proceed directly to the finish line after leaving the mark indicated by an asterisk (*) in the courses listed.
- 15.2 Courses may be shortened after the start in accordance with RRS 32.

16. Penalty System

- 16.1 Protests are to be lodged in accordance with RRS 61 and requests for redress in accordance with RRS 62 as amended below.
- 16.2 Protests and requests for redress shall be lodged in writing in person or by electronic means with either of the Organising Clubs.
- 16.3 The time limit for the lodging of protests or requests for redress involving an incident in the racing area will be 90 minutes after the last boat has finished the last race of the day, or the race committee signals no more racing today, whichever is later. This changes RRS 61 and 62.
- 16.4 Your attention is drawn to RRS Rule 44.1 and RRS Rule 44.2.
- 16.5 Any boats reported by NSW BSOs as having contravened TfNSW regulations shall be disqualified without a hearing. This amends RRS 63.1. Any alleged infringement of this clause shall not be grounds for protest by another competitor.

17. Scoring

- 17.1 The Low Point System, RRS Appendix A, applies including the provisions of RRS Appendix A5.3, subject to the amendments detailed below.
- 17.2 When fewer than six (6) races have been completed, a boat's series score will be the total of her race scores.
- 17.3 When six (6) or more races have been completed, a boat's series score will be the total of her race scores excluding her worst score.
- 17.4 All races may be scored separately in an Organising Club's point score series at their discretion.

18. Prizes

18.1 There are no prizes, only glory!

19. Further Information

19.1 For further information please contact:

- MHYC email: sailing@mhyc.com.au or telephone: (02) 9969 1244
- MYC email: sailing@myc.org.au or telephone: (02) 9977 4949

19.2 A presentation and get together may be held at each of the Organising Clubs after racing. Competitors are welcome to attend any of these presentations.



YACHT MANLY SPRINT SERIES – NOR

Invitation

Manly Yacht Club invites yachts to participate in up to 2 Sundays of racing, consisting of up to 3 short, sharp windward/return races per day. A great way to hone your skills, this fun regatta is followed by a prizegiving, food and frivolities on the deck of MYC, with a grand prize drawn from the barrel on the final day of racing.

1. Rules

- 1.1 The racing will be governed by the rules as defined in the current Racing Rules of Sailing (RRS) and any General Conditions of Racing as defined by the Organising Authority, except as altered by the Sailing Instructions which are also considered part of the rules.
- 1.2 The Organising Authority (OA) for this series is Manly Yacht Club (MYC).
- 1.3 Races from the Combined Clubs Sunday Series are included in this series, which may have a different Organising Authority for the purpose of conducting those races.
- 1.4 The Sailing Instructions will be those of the Combined Clubs Sunday, other than as modified by this NOR.
- 1.5 MYC may amend this Notice of Race. Amendments will be published on the Official Notice Board on the MYC website www.myc.org.au

2. Eligibility and Entry

- 2.1 A division must be constituted by a minimum of four yachts.

3. Fees

- 3.1 Entry fees are listed in Section 5.1, Racing Fees in the MYC Handbook.

4. Schedule

- 4.1 The schedule of races is shown in Section 5.8 MYC Calendar.
- 4.2 For information, all races in this series are included in the Combined Clubs Sunday Series, races 2, 3, 4, 7, 8, & 9.

5. Divisions and Handicaps

- 5.1 The following divisions will be sailed:
 - Yachts - Division 1 for yachts with spinnaker and PHS handicap.
 - Yachts - Division 2 for yachts with and without spinnaker and PHS handicap.

6. Scoring

- 6.1 The PHS Handicap system will be used to score a boat's result and adjust her handicap.
- 6.2 A boat's series score will be the total of her race scores with no excluded scores.
- 6.3 The number of races required to constitute a series is 3.

7. Prizes

- 7.1 Prizes will be awarded on the deck at the end of the day's racing. All prizes not immediately accepted by competitors or their representatives will be redrawn.
- 7.2 Grand Prizes, where applicable, will be drawn from the "barrel" on the last day of racing in the series.

8. Further Information

- 8.1 A BBQ and presentation will be held on the MYC balcony after racing.

YACHT MARATHON SERIES – NOR

Invitation

An invitation is extended to yachts 6m to 20m to join Manly Yacht Club racing around the islands of Sydney Harbour. This series, conducted on up to 2 Sundays in the summer months, allows yachts to explore the western reaches of the Harbour. This series allocates a start time for each boat based on previous performance. Spinnakers are allowed if nominated.

1. Rules

- 1.1 The racing will be governed by the rules as defined in the Racing Rules of Sailing (RRS) and the General Conditions of Racing as defined by Section 7 of the MYC Handbook, except as altered by the Sailing Instructions which are also considered part of the rules.
- 1.2 The Organising Authority may amend this Notice of Race. Amendments will be published on the Official Notice Board on the MYC website www.myc.org.au.

2. Eligibility and Entry

- 2.1 Entry is open to mono hull sailing yachts with length overall from 6m to 20m or at the Race Committee's discretion.
- 2.2 Boats must hold a Category 7 AS Equipment Audit Form.

3. Fees

- 3.1 Entry fees are listed in Section 5.1, Racing Fees of the MYC Handbook.

4. Schedule

- 4.1 The schedule of race days is shown in Section 5.8 MYC Calendar.
- 4.2 There is 1 Pursuit TCF Race scheduled for each class/division per day.
- 4.3 The following classes/divisions will be sailed:
 - Yachts - Division 1
 - Yachts - Division 2

5. Racing Area

- 5.1 Racing will be conducted within Sydney Harbour.

6. Prizes

- 6.1 Prizes will be awarded on the deck at the end of the day's racing. All prizes not immediately accepted by competitors or their representatives will be redrawn.
- 6.2 Grand Prizes, where applicable, will be drawn from the "barrel" on the last day of racing in the series.

7. Further Information

- 7.1 A BBQ and presentation will be held on the MYC balcony after racing.



PEPPER TREE WINES

YACHT MARATHON SERIES – SI

1. Rules

- 1.1 The racing will be governed by the rules as defined in the Racing Rules of Sailing (RRS) and the General Conditions of Racing as defined by Section 7 of the MYC Handbook, except as altered by the Sailing Instructions which are also considered part of the rules.

2. Schedule of Races

- 2.1 The schedule of race days is shown in Section 5.8 MYC Calendar.
 2.2 There is 1 Pursuit TCF Race scheduled for each class/division per day.
 2.3 The following classes/divisions will be sailed:
- Yachts - Division 1
 - Yachts - Division 2
- 2.4 The earliest start for the first yacht will be 1130 hrs for all divisions.

3. Class Flags

- 3.1 The class flags will be as follows:

CLASS	FLAG
Yachts – Division 1	Numeral Pennant 1
Yachts – Division 2	Numeral Pennant 2

4. The Courses

- 4.1 Courses are shown in Appendix 12.A7.
 4.2 All channel markers west of the Harbour Bridge will be respected.
 4.3 The pylons around Spectacle Island are permanent moorings and therefore are treated as obstructions.

5. The Start

- 5.1 The start will be on the Committee Boat line as described in Sections 7.10 and 7.13 General Conditions of Racing. If there is no ILCA racing scheduled on the day, the start will be from the clubhouse triangles as described in Sections 7.11 and 7.13 General Conditions of Racing.

6. The Finish

- 6.1 The finish will be on either the Committee Boat line or the clubhouse triangles as described in Section 7.14 General Conditions of Racing

7. Time Limits

- 7.1 The time limit for the races shall be 1730 hours.

8. Penalty System

- 8.1 Your attention is drawn to RRS Rule 44.1 and RRS Rule 44.2. RRS Rule 44.2 states in part that 'a boat takes a One-Turn or Two-Turns Penalty promptly by making the required turns in the same direction, each including one tack and one gybe'.
 8.2 If a Discretionary Penalty is accepted, it shall be a scoring penalty of 50% of the difference between a boat's non-penalized score and the score for DSQ. Half points shall be rounded up and the points of the other boats shall not be adjusted.

9. Scoring

- 9.1 The PHS Handicap system will be used to score a boat's result and adjust her handicap.
 9.2 The number of races scheduled for the series is shown in Section 5.8 MYC Calendar.
 9.3 The elapsed time is from the Allocated Start Time to the yacht's finish time.
 9.4 The number of races required to constitute a series will be the number of races scheduled in the series.
 9.5 A boat's series score will be the total of her race scores with no excluded scores.
 9.6 A boat's Allocated Start Time may be adjusted for any race.

10. Further Information

- 10.1 A BBQ and presentation will be held on the MYC balcony after racing.

YACHT OFFSHORE SERIES

Invitation

Manly Yacht Club conducts a number of short offshore races during daylight hours using a performance-based handicapping system. MYC invites competitors to enjoy the racing and hospitality provided. Where races do not finish in Sydney Harbour, berthing and dining facilities may be arranged for the conclusion of the racing.

The schedule of race days is shown in Section 5.8 MYC Calendar.

The Notice of Race for each race will be available via the MYC website www.myc.org.au at least one month prior to the event.

The Sailing Instructions for each race will be available via the MYC website www.myc.org.au at least one week prior to the event.

The Trusted Name in Sailmaking



SAILMAKERS

**Specializing in New Racing & Cruising Sails,
100% Australian Owned & Manufactured**

Covers & Furling Systems ~ Repairs & Recuts

19 West St., Brookvale NSW 2100
P: +61 2 9905 0800 E: sails@hoodaustralia.com.au

YACHT SUMMER SERIES – NOR

Invitation

An invitation is extended by Manly Yacht Club, to compete in the Summer Series around the harbour on Sunday afternoons for yachts between 6m and 20m. This series give skippers and crews the experience to transition from casual twilight racing to staggered daylight starts from the committee boat before progressing to the scratch starts of the more competitive Club Championships. Nominate your intention to fly a kite or not. These series allocate a start time for each boat based on previous performance.

1. Rules

- 1.1 The racing will be governed by the rules as defined in the Racing Rules of Sailing (RRS) and the General Conditions of Racing as defined by Section 7 of the MYC Handbook, except as altered by the Sailing Instructions which are also considered part of the rules.
- 1.2 The Organising Authority may amend this Notice of Race Amendments will be published on the Official Notice Board on the MYC website www.myc.org.au.

2. Eligibility and Entry

- 2.1 Racing is open to mono hull sailing yachts with length overall from 6m to 20m or at the Race Committee's discretion.
- 2.2 Yachts must hold a Category 7 AS Equipment Audit Form.

3. Fees

- 3.1 Entry fees are listed in Section 5.1, Racing Fees in the MYC Handbook.

4. Schedule

- 4.1 The schedule of race days is shown in Section 5.8 MYC Calendar.
- 4.2 The following classes/divisions will be sailed:
 - Yachts
- 4.3 There is 1 Pursuit TCF Race scheduled for each day.

5. Racing Area

- 5.1 Racing will be conducted within Sydney Harbour.

6. Prizes

- 6.1 Prizes will be awarded on the deck at the end of the day's racing. All prizes not immediately accepted by competitors or their representatives will be redrawn.
- 6.2 Grand Prizes, where applicable, will be drawn from the "barrel" on the last day of racing in the series.

7. Further Information

- 7.1 A BBQ and presentation will be held on the MYC balcony after racing.

YACHT SUMMER SERIES – SI

1. Rules

- 1.1 The racing will be governed by the rules as defined in the Racing Rules of Sailing (RRS) and the General Conditions of Racing as defined by Section 7 of the MYC Handbook, except as altered by the Sailing Instructions which are also considered part of the rules.

2. Schedule of Races

- 2.1 The schedule of race days is shown in Section 5.8 MYC Calendar.
 2.2 The following classes/divisions will be sailed:
 - Yachts
 2.3 There is 1 Pursuit TCF Race scheduled for each day.
 2.4 The earliest start for the first yacht will be 1230 hrs.

3. Class Flags

- 3.1 The class flags will be as follows:

CLASS	FLAG
Yachts	Numeral Pennant 1

4. The Courses

- 4.1 The courses are as shown in Appendix 12.A6.

5. The Start

- 5.1 The start will be on the Committee Boat line as described in Sections 7.10 and 7.13 General Conditions of Racing. If there is no ILCA racing scheduled on the day, the start will be from the club triangles as described in Sections 7.11 and 7.13 of the General Conditions of Racing.

6. The Finish

- 6.1 The finish will be on either the Committee Boat line or the clubhouse triangles as described in Section 7.14 General Conditions of Racing.

7. Time Limits

- 7.1 Subject to 7.2 the time limit for the yachts will be 1700 hours.
 7.2 If the first boat finishes between 1630 hours and 1700 hours the time limit shall be extended by 30 minutes from the finishing time of the first boat for that division or 1730 hours whichever is soonest.

8. Penalty System

- 8.1 Your attention is drawn to RRS Rule 44.1 and RRS Rule 44.2. RRS Rule 44.2 states in part that 'a boat takes a One-Turn or Two-Turns Penalty promptly by making the required turns in the same direction, each including one tack and one gybe'.
 8.2 If a Discretionary Penalty is accepted, it shall be a scoring penalty of 50% of the difference between a boat's non-penalized score and the score for DSQ. Half points shall be rounded up and the points of the other boats shall not be adjusted.

9. Scoring

- 9.1 The PHS Handicap system will be used to score a boat's result and adjust her handicap.
 9.2 The elapsed time is from the Allocated Start Time to the yacht's finish time.
 9.3 When 7 or 8 races have been completed, a boat's series score will be the total of her series scores excluding her worst score.
 9.4 The number of races scheduled for the series is shown in Section 5.8 MYC Calendar.
 9.5 A boat's Allocated Start Time may be adjusted for any race, but cannot be adjusted to be earlier than 1230 hrs.
 9.6

10. Further Information

- 10.1 A BBQ and presentation will be held on the MYC balcony after racing.

YACHT TWILIGHT SERIES – NOR

Invitation

Manly Yacht Club conducts a non-spinnaker race series on a Friday evening during the Twilight season. An invitation is extended to yacht owners and crew to participate in this fun series; easily one of the best ways to relax at the end of the week. In addition, female helms are invited to participate in the Twilight Female Helm Series which is held in conjunction with the main Twilight Series.

1. Rules

- 1.1 The racing will be governed by the rules as defined in the Racing Rules of Sailing (RRS) and the General Conditions of Racing as defined by Section 7 of the MYC Handbook, except as altered by the Sailing Instructions which are also considered part of the rules.
- 1.2 The Organising Authority may amend this Notice of Race. Amendments will be published on the Official Notice Board on the MYC website www.myc.org.au.

2. Eligibility and Entry

- 2.1 Entry is open to mono hull sailing yachts with length overall from 6m to 20m or at the Race Committee's discretion.
- 2.2 Boats must hold a Category 7 AS Equipment Audit Form. In addition, boats must carry and show navigation lights to comply with the International Regulations for Preventing Collision at Sea.
- 2.3 Yachts may only compete in the Twilight Female Helm Series using the nominated helm(s). Written notice of changes to helm may be considered by the Race Director.

3. Fees

- 3.1 Entry fees are listed in Section 5.1, Racing Fees in the MYC Handbook.

4. Schedule

- 4.1 The schedule of race days is shown in Section 5.8 MYC Calendar.
- 4.2 The following classes/divisions will be sailed:
 - Yachts – Non-Spinnaker
- 4.3 There is 1 Pursuit Race scheduled per day.

5. Racing Area

- 5.1 Racing will be conducted within Sydney Harbour.

6. Prizes

- 6.1 Prizes will be awarded on the deck at the end of the day's racing. All prizes not immediately accepted by competitors or their representatives will be redrawn.
- 6.2 Grand Prizes, where applicable, will be drawn from the "barrel" on Presentation Night.

7. Further Information

- 7.1 A presentation and dinner service will be held on the MYC balcony after racing.



PEPPER TREE WINES

YACHT TWILIGHT SERIES – SI

1. Rules

- 1.1 The racing will be governed by the rules as defined in the Racing Rules of Sailing (RRS) and the General Conditions of Racing as defined by Section 7 of the MYC Handbook, except as altered by the Sailing Instructions which are also considered part of the rules.

2. Schedule of Races

- 2.1 The following of race days is shown in Section 5.8 MYC Calendar.
 2.2 The following classes/divisions will be sailed:
- Yachts – Non-Spinnaker
- 2.3 There is 1 Pursuit Race scheduled per day.
 2.4 The earliest start for the first boat will be 1800 hrs.

3. Class Flags

- 3.1 The class flags will be as follows:

CLASS	FLAG
Yachts – Non-Spinnaker	MYC Burgee

4. The Courses

- 4.1 Courses are shown in Appendix 12.A5.

5. The Start

- 5.1 All races will be Pursuit starts from the clubhouse triangles as described in Sections 7.11 and 7.13 General Conditions of Racing.

6. The Finish

- 6.1 The finish will be on the clubhouse triangles as described in Section 7.15 General Conditions of Racing.
 6.2 At the beginning and end of the Twilight Series it can often still be dark making it difficult for the Race Committee to identify finishing yachts' sail numbers. It is requested that all yachts finishing in these times shine a bright torch onto their sail numbers to help the RC in identifying the finishing yacht. Failure to do this will NOT be considered grounds for a Protest either by the RC or other competitors.

7. Time Limits

- 7.1 The time limit for all races will be 2015 hours.

8. Protests and Requests for Redress

- 8.1 As twilights are a friendly race series, accepting protest arbitration is encouraged.

9. Penalty System

- 9.1 The racing rules will be modified in accordance with RRS Rule 86 as follows: RRS Rule 44.1 and RRS Rule 44.2 are changed so that only **one** turn, including one tack and one gybe, is required. This, changes 7.18 General Conditions of Racing.
 9.2 If a Discretionary Penalty is accepted, it shall be a scoring penalty of 50% of the difference between a boat's non-penalized score and the score for DSQ. Half points shall be rounded up and the points of the other boats shall not be adjusted.

10. Twilight Scoring

- 10.1 A boat's series score will be the total of her series score excluding her worst 5 scores, unless less than 19 races have been completed, in which case her 3 worst scores will be excluded.
 10.2 The PHS Handicap system will be used to score a boat's result and adjust her handicap.
 10.3 A boat's start time cannot be adjusted to be earlier than 1800 hrs.

11. Twilight Female Helm Series

- 11.1 The Twilight Female Helm Series is a sub series of the Twilight Series that must be separately entered **in addition to** an entry in the Twilight series. The Twilight Female Helm series has additional results calculated from the corresponding Twilight series race.
- 11.2 Twilight Female Helm races will be scored as Pursuit TCF Races using the same Allocated Start Time as the Twilight Series.
- 11.3 The PHS allocated for a Twilight Female Helm race may differ to the PHS allocated for the normal Twilight race results as the Twilight Female Helm PHS calculation will only include Twilight Female Helm races.
- 11.4 The Allocated Start Time is the published start time for the boat in the Twilight Series.
- 11.5 When 4 or more races have been completed, a boat's series score will be the total of her series scores excluding her worst score.
- 11.6 A series is constituted by the completion of 3 races.

12. Safety Regulations

- 12.1 Boats must carry and show navigation lights in compliance with the International Regulations for Preventing of Collision at Sea and TfNSW requirements for navigation lights.
- 12.2 Competitors who fail to notify the Race Committee of their withdrawal, or who fail to notify that they will not finish within the time limit, will receive a penalty of 5 minutes added to their next start time in the following race.

13. Further Information

- 13.1 A presentation and dinner service will be held on the MYC balcony after racing.



(02) 9524 7056
ianshort600@gmail.com
www.ianshortsails.com.au

IAN SHORT SAILS
High Performance Racing and Durable Cruising Sails

<p>Factory 11 141 Taren Point Road, Caringbah, N.S.W. 2229</p>	<p>Free Quotations Personal Attention</p>
--	--

YACHT WINTER SERIES – NOR

Invitation

An invitation is extended by Manly Yacht Club, to compete in a Winter Series around the harbour on Sunday afternoons for yachts between 6m and 20m. The series gives skippers and crews the experience to transition from casual twilight racing to staggered daylight starts before progressing to the scratch starts of the more competitive Club Championships. Nominate your intention to fly a kite or not. This race format is Pursuit TCF. Each boat has an individual allocated start time and results are determined based on corrected time.

1. Rules

- 1.1 The racing will be governed by the rules as defined in the Racing Rules of Sailing (RRS) and the General Conditions of Racing as defined by Section 7 of the MYC Handbook, except as altered by the Sailing Instructions which are also considered part of the rules.
- 1.2 The Organising Authority may amend this Notice of Race. Amendments will be published on the Official Notice Board on the MYC website www.myc.org.au.

2. Eligibility and Entry

- 2.1 Entry is open to mono hull sailing yachts with length overall from 6m to 20m or at the Race Committee's discretion.
- 2.2 Boats must hold a Category 7 AS Equipment Audit Form.

3. Fees

- 3.1 Entry fees are listed in Section 5.1, Racing Fees in the MYC Handbook.

4. Schedule

- 4.1 The schedule of race days is shown in Section 5.8 MYC Calendar.
- 4.2 The following classes/divisions will be sailed:
 - Yachts – Division 1
 - Yachts – Division 2
- 4.3 There is 1 Pursuit TCF Race scheduled for each division per day.

5. Racing Area

- 5.1 Racing will be conducted within Sydney Harbour.

6. Prizes

- 6.1 Prizes will be awarded on the deck at the end of the day's racing. All prizes not immediately accepted by competitors or their representatives will be redrawn.
- 6.2 Grand Prizes, where applicable, will be drawn from the "barrel" on the last day of racing in the series.

7. Further Information

- 7.1 A BBQ and presentation will be held on the MYC balcony after racing.

YACHT WINTER SERIES – SI

1. Rules

- 1.1 The racing will be governed by the rules as defined in the Racing Rules of Sailing (RRS) and the General Conditions of Racing as defined by Section 7 of the MYC Handbook, except as altered by the Sailing Instructions which are also considered part of the rules.

2. Schedule of Races

- 2.1 The schedule of race days is shown in Section 5.8 MYC Calendar.
 2.2 The following classes/divisions will be sailed:
 - Yachts - Division 1
 - Yachts - Division 2
 2.3 There is 1 Pursuit TCF Race scheduled for each class/division per day.
 2.4 The earliest start for the first boat will be 1200 hrs.

3. Class Flags

- 3.1 The class flags will be as follows:

CLASS	FLAG
Yachts – Division 1	Numeral Pennant 1
Yachts – Division 2	Numeral Pennant 2

4. The Courses

- 4.1 Courses for division 1 are shown in Appendix 12.A8.
 4.2 Courses for division 2 are shown in Appendix 12.A9.

5. The Start

- 5.1 All races will start from the clubhouse triangles as described in Sections 7.11 and 7.13 General Conditions of Racing.

6. The Finish

- 6.1 The finish will be on the clubhouse triangles as described in Section 7.15 General Conditions of Racing.
 6.2 In addition to RRS32, some courses can be shortened at a mark indicated with (*). When, prior to the first boat rounding the mark indicated with (*), the S flag is displayed on the club flagstaff, then boats should round the mark and proceed directly to the finish. The Race Officer shall attempt to notify the fleet via VHF of the course change.

7. Time Limits

- 7.1 The time limit for all races will be 1630 hours.

8. Penalty System

- 8.1 Your attention is drawn to RRS Rule 44.1 and RRS Rule 44.2. RRS Rule 44.2 states in part that 'a boat takes a One-Turn or Two-Turns Penalty promptly by making the required turns in the same direction, each including one tack and one gybe'.
 8.2 If a Discretionary Penalty is accepted, it shall be a scoring penalty of 50% of the difference between a boat's non-penalized score and the score for DSQ. Half points shall be rounded up and the points of the other boats shall not be adjusted.

9. Scoring

- 9.1 When from 5 to 6 races have been completed, a boat's series score will be the total of her series scores excluding her worst 1 score.
 9.2 The PHS handicap system will be used to score a boat's result and adjust her handicap.
 9.3 A boat's Allocated Start Time may be adjusted for any races, but cannot be adjusted to be any earlier than 1200 hrs.

10. Further Information

- 10.1 A BBQ and presentation will be held on the MYC balcony after racing.

HELLYHANSEN.COM



BELONG IN THE MOMENT

Pip Hare is one of only ten women to ever complete the Vendée Globe. She has to trust herself, her team and her gear to sail in extreme conditions, thousands of miles from land. But no matter what the ocean throws at her, Pip knows this is where she belongs.

HH[®]
ALIVE
SINCE / 1877

 TRUSTED BY
PROFESSIONALS

PIP HARE - PROFESSIONAL SOLO SAILOR

WOMEN'S CHALLENGE

Invitation

Manly Yacht Club Helly Hansen Women's Challenge **Saturday 22nd March 2025** for ILCAs, Hansa 303s and Junior classes; and **Sunday 23rd March 2025** for Yachts.

This popular racing event is Manly Yacht Club's signature event, reflecting the growing passion women have for the sport of sailing. It is the most popular event on the women's sailing calendar.

Manly Yacht Club extends an invitation to female sailors to join us for the weekend of exciting racing in Manly Cove and on Sydney Harbour followed by an evening of prize giving, food and frivolities on the deck at Manly Yacht Club.

Competition covers every level of experience and age; and encourages all women/girl sailors to borrow, beg or buy a boat and enter. Divisions are open in Junior classes, Hansa Dinghies and ILCAs on Saturday offering one design racing. Sunday racing on boats 6m to 20m, includes one design racing (fleet number dependent). Mixed fleet divisions will be all female, or female helm with mixed crew, nominating spinnaker or not, within the fleets and racing under PHS. Exciting racing and wonderful prizes.

The Notice of Race will be available via the MYC website www.myc.org.au at least one month prior to the event.

The Sailing Instructions will be available via the MYC website www.myc.org.au at least one week prior to the event.



SCOTT SAILS

- Custom Race & Cruising
- Furler Supply & Install
- Boat Covers & Cushions
- Now the NSW dealer for Elvstrøm Sails

9948 8945
0412 288 945
info@scottsails.com.au
www.scottsails.com.au
1/67 Kenneth Road Manly Vale NSW 2093



12. APPENDICES

A1 JUNIOR & YOUTH COURSES

Courses may be sailed to Port or Starboard as indicated by a red or green flag displayed on the Committee Boat. If no flag is displayed the courses will be sailed as shown. For all courses, the leg length from start line to top mark should be around 0.4NM.)

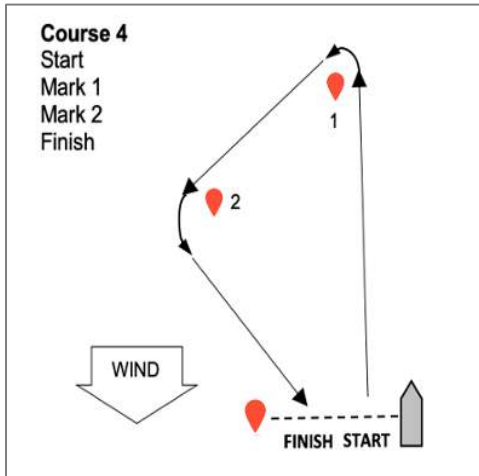
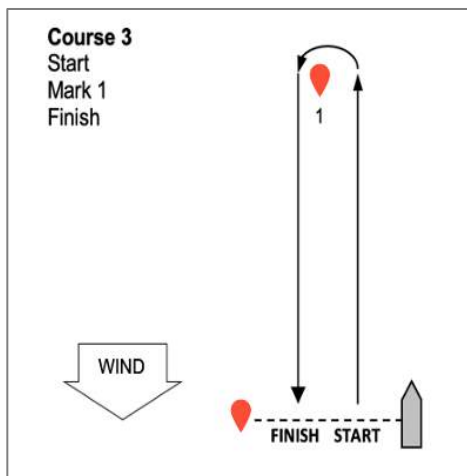
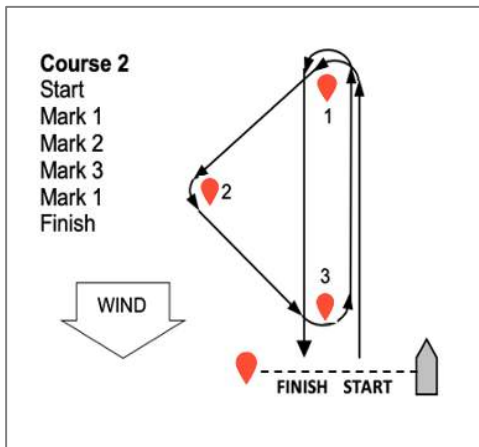
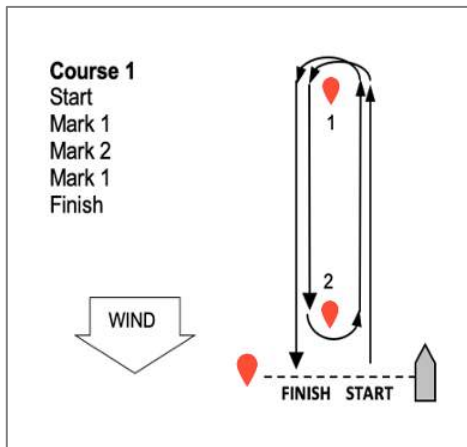

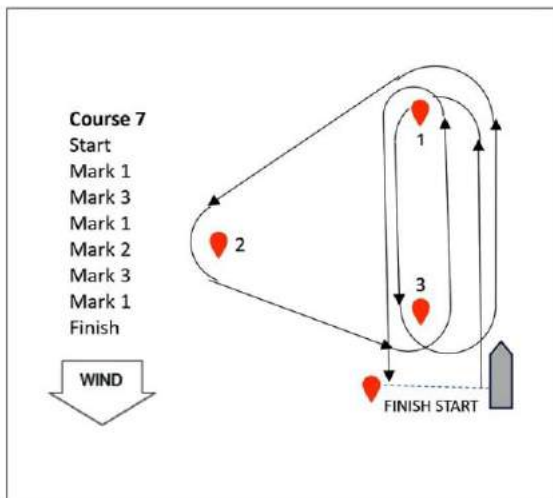
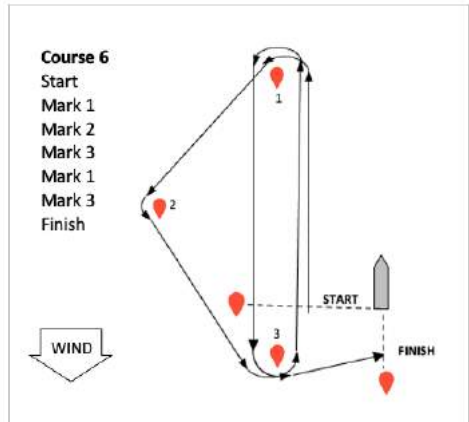
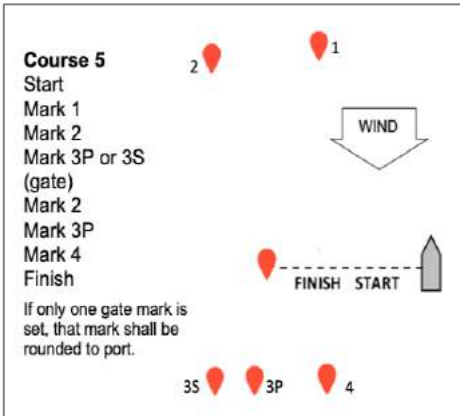

Course 8

The top mark for the blue course will be proportionally further up to windward than shown and the course diagram. ILCA 4s and ILCA 6s will sail the blue course and Gold and Silver O'pen Skiffs will sail the red course.

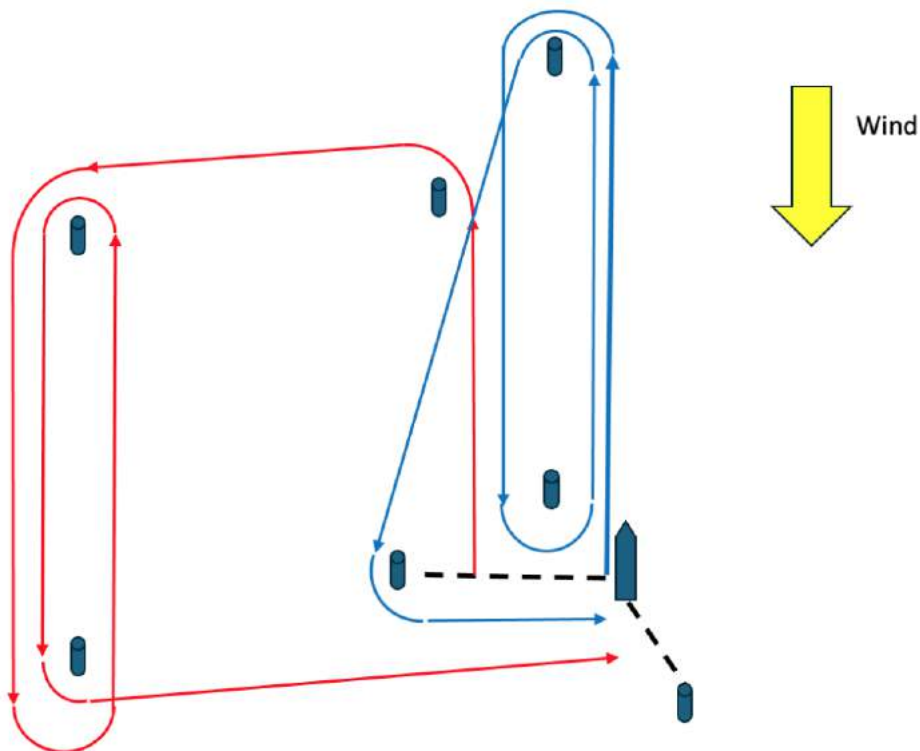

A2 ILCA COURSES

- 1.1 The Course as described in Table 1 below shall be displayed on a board on the committee vessel, before or with the Warning Signal.
- 1.2 Marks 1S - 1P may be replaced by a singular Mark 1, which shall be rounded to port and coloured the same as the two marks it replaces.
- 1.3 Marks 2S/2P may be replaced by a singular Mark 2, which shall be rounded to port and coloured the same as the two gate marks it replaces.
- 1.4 The indicative course layout is shown in illustration 1. The diagram is approximate only and is not to scale.

Table 1 – Courses and Course Descriptions

COURSE	COURSE DESCRIPTION
	<i>Windward - Leeward Course (CC and LM)</i>
1	Start – 1S - 1P – 2S/2P – Finish (1 lap)
2	Start – 1S - 1P – 2S/2P – 1S - 1P – 2S/2P – Finish (2 laps)
3	Start – 1S - 1P – 2S/2P – 1S - 1P – 2S/2P – 1S - 1P – 2S/2P – Finish (3 laps)
	<i>Harry Anderson Course - Port rounding (4P)</i>
4	Start – 1P – 2P – S/F – 3P – 1P – 2P – S/F – 3P – Finish (2 laps)
5	Start – 1P – 2P – S/F – 3P – 1P – 2P – S/F – 3P – 1P – 2P – S/F – 3P – Finish (3 laps)
	<i>Harry Anderson Course - Starboard rounding (4P)</i>
6	Start – 1S – 2S – S/F – 3S – 1S – 2S – S/F – 3S – Finish (2 laps)
7	Start – 1S – 2S – S/F – 3S – 1S – 2S – S/F – 3S – 1S – 2S – S/F – 3S – Finish (3 laps)
	<i>Figure 8 Courses (CC)</i>
8	Start – 1P – 2P – 3S – 4S – 1P – 4S – Finish (2 laps)
9	Start – 1S – 2S – 3P – 4P – 1S – 4P – Finish (2 laps)

Courses 1-3: Windward - Leeward Course (CC and LM)

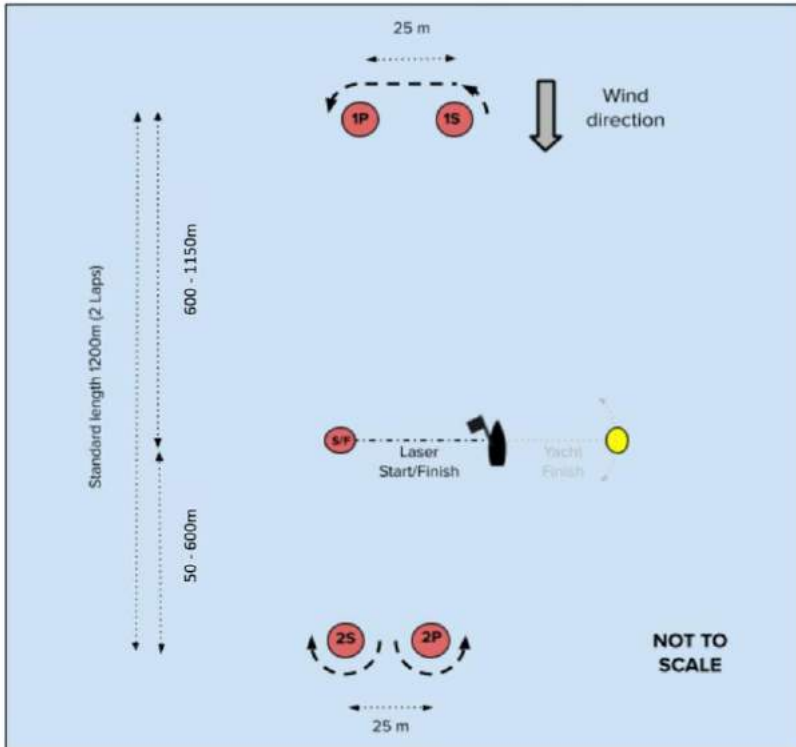

Courses 4-7: Harry Anderson Course - Port and Starboard rounding (4P)

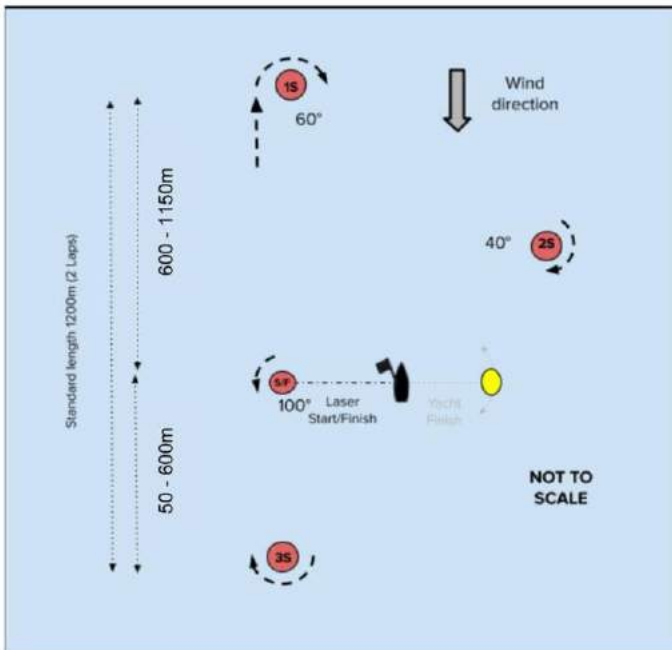
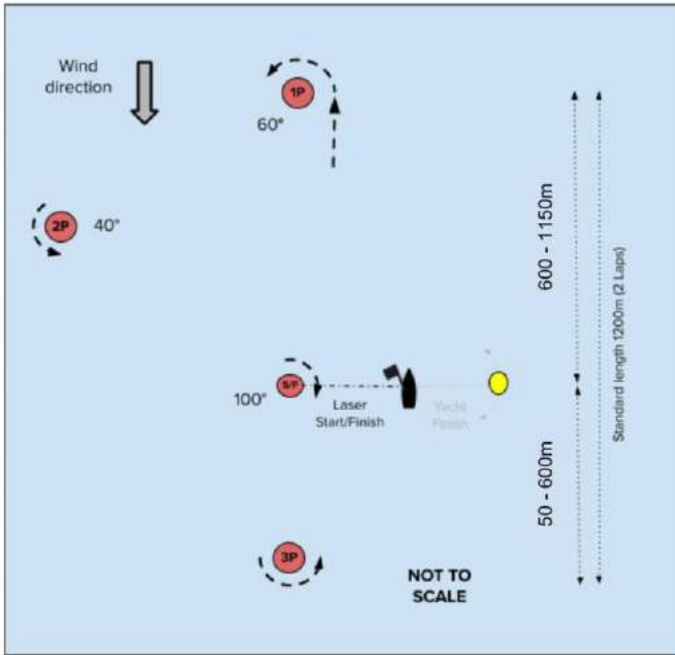

Courses 8-9: Figure 8 Courses - (CC)

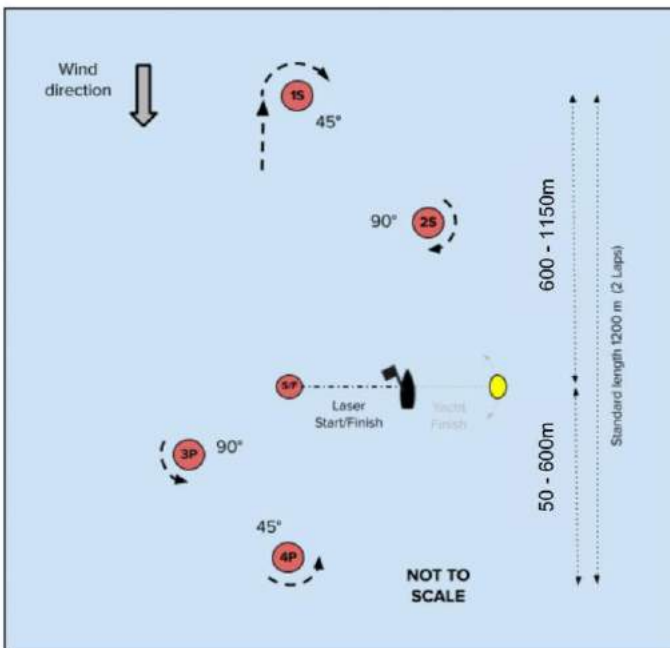
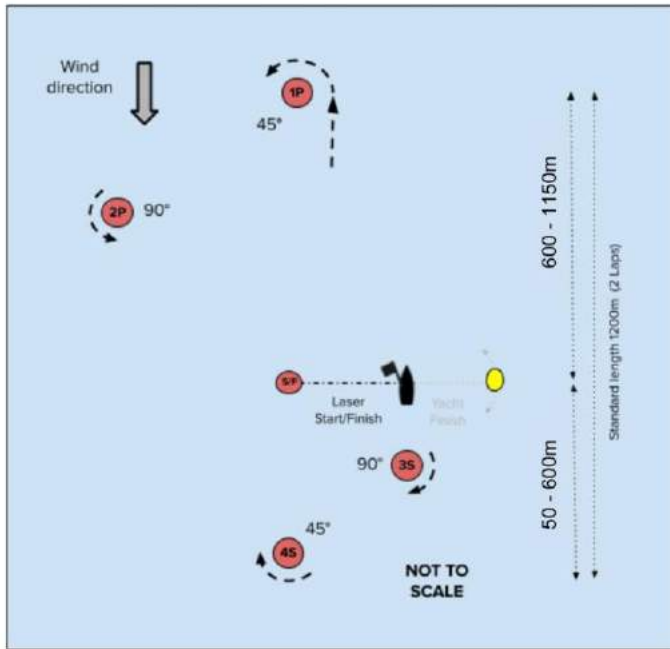

A3 CLUB CHAMPIONSHIP & COMBINED CLUBS SUNDAY SERIES DIVISION 1 COURSES

COURSE 1 NE 13.5NM

Start Hunters Bay,
Manly West AS, Manly East AS,
Rocky Point AS, Edwards Beach AS,
Cannae Point AS, Taylors Bay AS (*),
Cannae Point AS, Obelisk Bay AS,
Finish North Harbour

COURSE 2 E 13.5NM

Start Hunters Bay,
Quarantine Head,
Rocky Point AS, Edwards Beach AS,
Quarantine Head,
Grotto Point AS, Cannae Point AS,
Rocky Point AS, Edwards Beach AS (*),
Quarantine Head,
Rocky Point AS, Edwards Beach AS,
Finish North Harbour

COURSE 3 SE 13.5NM

Start Grotto Point ,
Rose Bay AS, Taylors Bay AS,
Rose Bay AS, Grotto Point AS (*),
Lady Bay AS, Grotto Point AS,
Finish Watsons Bay

COURSE 4 S 13.5NM

Start North Harbour,
Lady Bay AS,
Manly West AS, Manly East AS,
Eastern Channel AS,
Manly West AS, Manly East AS (*),
Lady Bay AS,
Manly West AS, Manly East AS,
Finish North Harbour

COURSE 5 SW 13.5NM

Start North Harbour,
Rocky Point AS, Edwards Beach AS,
Cannae Point AS, Taylors Bay AS,
Cannae Point AS (*), Chowder Bay South AS,
Cannae Point AS,
Finish Hunters Bay

COURSE 6 W 12NM

Start North Harbour,
Rocky Point AS, Edwards Beach AS,
Quarantine Head,
Rocky Point AS, Edwards Beach AS,
Cannae Point AS,
Rocky Point AS, Edwards Beach AS (*),
Quarantine Head, Grotto Point AS,
Finish North Harbour

COURSE 7 NW 13NM

Start Camp Cove,
Rocky Point AS, Edwards Beach AS,
Lady Bay AS, Grotto Point AS,
Lady Bay AS, Grotto Point AS,
Lady Bay AS (*),
Manly West AS, Many East AS,
Lady Bay AS,
Finish Grotto Point

COURSE 8 N 13.5NM

Start Camp Cove,
Manly West AS, Manly East AS,
Lady Bay AS, Cannae Point AS,
Eastern Channel AS (*),
Manly West AS, Manly East AS,
Lady Bay AS,
Finish North Harbour

COURSE 9 NE ALT 13NM

Start Hunters Bay,
Manly West AS, Manly East AS,
Lady Bay AS, Taylors Bay AS (*),
Cannae Point AS, Taylors Bay AS,
Finish North Harbour

COURSE 10 S ALT 12NM

Start North Harbour,
Shark Island AS, Shark Island (*),
Manly West AS, Manly East AS,
Neilson Park AS,
Finish North Harbour

COURSE 11 SE OR SW ALT 13NM

Start North Harbour,
Cannae Point AS,
Rocky Point AS, Edwards Beach AS,
Grotto Point AS, Lady Bay AS,
Rose Bay AS, Taylors Bay AS (*),
Grotto Point AS, Lady Bay AS,
Finish North Harbour

A4 CLUB CHAMPIONSHIP & COMBINED CLUBS SUNDAY SERIES DIVISION 2 COURSES

COURSE 1 NE 11NM

Start Hunters Bay,
Manly West AS, Manly East AS,
Rocky Point AS, Edwards Beach AS,
Cannae Point AS, Obelisk Bay AS (*),
Cannae Point AS, Obelisk Bay AS,
Finish North Harbour

COURSE 2 E 12NM

Start Hunters Bay,
Quarantine Head, Grotto Point AS,
Quarantine Head, Grotto Point AS,
Cannae Point AS,
Rocky Point AS, Edwards Beach AS (*),
Quarantine Head,
Rocky Point AS, Edwards Beach AS,
Finish North Harbour

COURSE 3 SE 11.5NM

Start Grotto Point,
Neilson Park AS, Chowder Bay South AS,
Rose Bay AS, Grotto Point AS (*),
Lady Bay AS, Grotto Point AS,
Finish Watsons Bay

COURSE 4 S 11.5NM

Start North Harbour,
Eastern Channel AS,
Manly West AS, Manly East AS (*),
Lady Bay AS,
Manly West AS, Manly East AS,
Finish North Harbour

COURSE 5 SW 11.5NM

Start North Harbour,
Rocky Point AS, Edwards Beach AS,
Cannae Point AS, Obelisk Bay AS,
Cannae Point AS (*), Chowder Bay South AS,
Cannae AS,
Finish Hunters Bay

COURSE 6 W 11NM

Start North Harbour,
Rocky Point AS, Edwards Beach AS,
Quarantine Head,
Grotto Point AS, Cannae Point AS,
Rocky Point AS, Edwards Beach AS (*),
Quarantine Head, Grotto Point AS,
Finish North Harbour

COURSE 7 NW 10NM

Start Camp Cove,
Obelisk Bay AS,
Lady Bay AS, Grotto Point AS,
Lady Bay AS, Grotto Point AS,
Lady Bay AS (*),
Manly West AS, Manly East AS,
Lady Bay AS,
Finish Grotto Point

COURSE 8 N 10NM

Start Camp Cove,
Cannae Point AS, Lady Bay AS,
Cannae Point AS, Eastern Channel AS (*),
Manly West AS, Manly East AS,
Lady Bay AS,
Finish North Harbour

COURSE 9 NE ALT 11NM

Start Hunters Bay,
Manly West AS, Manly East AS,
Lady Bay AS,
Chowder Bay South AS (*), Cannae AS,
Chowder Bay South AS,
Finish North Harbour

COURSE 10 S ALT 11NM

Start North Harbour,
Neilson Park AS (*),
Manly West AS, Manly East AS,
Neilson Park AS,
Finish North Harbour

COURSE 11 SE OR SW ALT 10NM

Start North Harbour,
Cannae Point AS,
Rocky Point AS, Edwards Beach AS,
Grotto Point AS,
Lady Bay AS, Neilson Park AS,
Chowder Bay South AS (*),
Grotto Point AS, Lady Bay AS,
Finish North Harbour

A5 YACHT TWILIGHT COURSES

All marks to starboard UNLESS OTHERWISE INDICATED (P). Australian Sailing (AS) marks are permanent laid yellow spar buoys. All distances are approximate.

Course 1 (4.5 NM)

1. Start Manly
2. Sow and Pigs Reef
3. Finish Manly triangles

Course 2 (4.8 NM)

1. Start Manly
2. Sow and Pigs Reef
3. Obelisk Bay AS
4. Finish Manly triangles

Course 3 (5.0 NM)

1. Start Manly
2. Cannae Point AS(*)
3. Chowder Bay North AS
4. Finish Manly triangles

Course 4 (5.1 NM)

1. Start Manly
2. Cannae Point AS
3. Manly West and East AS
4. Cannae Point AS
5. Manly West and East AS(*)
6. Cannae Point AS
7. Manly West AS
8. Finish Manly triangles

Course 5 (5.4 NM)

1. Start Manly
2. Cannae Point AS
3. Sow and Pigs Reef(*)
4. Obelisk Bay AS
5. Grotto Point AS
6. Finish Manly triangles

Course 6 (5.5 NM)

1. Start Manly
2. Cannae Point AS
3. Grotto Point AS
4. Manly West AS(*)
5. Cannae Point AS
6. Grotto Point AS
7. Finish Manly triangles

Course 7 (5.7 NM)

1. Start Manly
2. Rocky Point AS
3. Edwards Beach AS(*)
4. Grotto Point AS
5. Rocky Point AS
6. Edwards Beach AS
7. Finish Manly triangles

Course 8 (6.0 NM)

1. Start Manly
2. Sow and Pigs Reef
3. Edwards Beach AS
4. Finish Manly triangles

Course 9 (6.0 NM)

1. Start Manly
2. East Channel AS
3. Chowder Bay South AS
4. Finish Manly triangles

(*) In addition to RRS32, some courses can be shortened at a mark indicated with (*). When, prior to the first boat rounding the mark indicated with (*), the S flag is displayed on the club flagstaff, then boats should round the mark and proceed directly to the finish. The Race Officer shall attempt to notify the fleet via VHF of course change.

A6 YACHT SUMMER SERIES COURSES

All marks to starboard UNLESS OTHERWISE INDICATED (P). Australian Sailing (AS) marks are permanent laid yellow spar buoys. All distances are approximate. The location of the finish is determined by 7.14 and 7.15 of the General Conditions of Racing.

COURSE 1 (11.3 NM)

1. Start Manly or triangles
2. Edwards Beach AS
3. Cannae Point AS
4. Shark Island AS & Shark Is (*)
5. Clark Island
6. Wedding Cake East (P)
7. Finish North Harbour or triangles

COURSE 2 (8.8 NM)

1. Start Reef Beach
2. Manly MYC
3. Shark Is AS & Shark Is (*)
4. Clark Island
5. Rocky Point AS
6. Edwards Beach AS
7. Finish North Harbour or triangles

COURSE 3 (11.6 NM)

1. Start Manly or triangles
2. Cannae Point AS
3. Rocky Point AS
4. Edwards Beach AS
5. Lady Bay AS
6. Chowder Bay South AS (*)
7. Chowder Bay North AS
8. Shark Island AS & Shark Is
9. Clark Island
10. Finish North Harbour or triangles

COURSE 4 (9.1 NM)

1. Start Manly or triangles
2. Cannae Point AS
3. Rocky Point AS
4. Edwards Beach AS
5. Grotto Point AS
6. Lady Bay AS
7. Nielsen Park AS (*)
8. Rose Bay AS
9. Chowder Bay North AS
10. Obelisk Bay AS
11. Finish North Harbour or triangles

COURSE 5 (8.6 NM)

1. Start Reef Beach
2. Manly MYC
3. Cannae Point AS
4. Obelisk Bay AS
5. Manly West and East AS (*)
6. Rocky Point AS
7. Manly West and East AS
8. Cannae Point AS
9. Finish North Harbour or triangles

COURSE 6 (10.4 NM)

1. Start Fairlight Beach
2. Rose Bay AS
3. Chowder Bay South AS (*)
4. Rose Bay AS
5. Shark Island AS and Shark Island
6. Finish North Harbour or triangles

COURSE 7 (10.7 NM)

1. Start Fairlight Beach
2. Eastern Channel AS
3. Chowder Bay North AS (*)
4. Rose Bay AS
5. Taylors Bay AS
6. Shark Island AS and Shark Island
7. Finish North Harbour or triangles

COURSE 8 (10.7 NM)

1. Start Manly or triangles
2. Rocky Point AS
3. Edwards Beach AS
4. Manly West and East AS (*)
5. Rocky Point AS
6. Edwards Beach AS
7. Cannae Point AS
8. Lady Bay AS
9. Finish North Harbour or triangles

COURSE 9 (9.0 NM)

1. Start Manly or triangles
2. Cannae Point AS
3. Lady Bay AS
4. Grotto Point AS
5. Cannae Point AS
6. Lady Bay AS (*)
7. Rocky Point AS
8. Edwards Beach AS
9. Grotto Point AS
10. Finish North Harbour or triangles

(*) In addition to RRS32, some courses can be shortened at a mark indicated with (*). When, prior to the first boat rounding the mark indicated with (*), the S flag is displayed by the committee vessel or on the club flagstaff, then boats should round the mark and proceed directly to the finish. The Race Officer shall attempt to notify the fleet via VHF of course change.

A7 YACHT MARATHONS DIVISION 1 AND 2 COURSES

All marks to starboard UNLESS OTHERWISE INDICATED (P). Australian Sailing (AS) marks are permanent laid yellow spar buoys. All distances are approximate. The location of the finish is determined by 7.14 and 7.15 of the General Conditions of Racing.

DIVISION 1 COURSES**Course 1 (16.6 NM)**

1. Start Manly
2. Shark Island AS & Shark Island
3. Clark Island
4. Fort Denison
5. Goat Island
6. Cockatoo Island
7. Snapper Island
8. Spectacle Island
9. Finish North Harbour or triangles

Course 2 (16.8 NM)

1. Start Manly
2. Shark Island AS & Shark Island
3. Clark Island
4. Fort Denison
5. Goat Island
6. Shark Island AS & Shark Island
7. Clark Island
8. Finish North Harbour or triangles

Course 3 (13.1 NM)

1. Start Manly
2. Shark Island AS & Shark Island
3. Clark Island
4. Fort Denison(*)
5. Goat Island
6. Finish North Harbour or triangles

Course 4 (16.1 NM)

1. Start Manly
2. Shark Island AS & Shark Island
3. Clark Island
4. Fort Denison
5. Goat Island
6. Cockatoo Island
7. Finish North Harbour or triangles

DIVISION 2 COURSES**Course 1 (13.1 NM)**

1. Start Manly
2. Shark Island AS & Shark Island
3. Clark Island
4. Fort Denison
5. Goat Island
6. Finish North Harbour or triangles

Course 2 (13.4 NM)

1. Start Manly
2. Shark Island AS & Shark Island
3. Clark Island
4. Fort Denison
5. Shark Island AS & Shark Island
6. Clark Island
7. Finish North Harbour or triangles

Course 3 (10.1 NM)

1. Start Manly
2. Shark Island AS & Shark Island
3. Clark Island(*)
4. Fort Denison
5. Finish North Harbour or triangles

Course 4 (13.1 NM)

1. Start Manly
2. Shark Island AS & Shark Island
3. Clark Island
4. Fort Denison
5. Goat Island
6. Finish North Harbour or triangles

(*) In addition to RRS32, some courses can be shortened at a mark indicated with (*). When, prior to the first boat rounding the mark indicated with (*), the S flag is displayed by the committee vessel or on the club flagstaff, then boats should round the mark and proceed directly to the finish. The Race Officer shall attempt to notify the fleet via VHF of course change.

A8 YACHT WINTER SERIES DIVISION 1 COURSES

All marks to starboard UNLESS OTHERWISE INDICATED (P). Australian Sailing (AS) marks are permanent laid yellow spar buoys. The courses 1 through 4 are approximately aligned with the wind directions indicated below. Courses 5-8 are interesting alternative courses that are not particular to wind direction. All distances are approximate.

Course 1 N,S 9.5nm

1. Start Manly (triangles)
2. Nielsen Park AS
3. Manly West AS (*)
4. Manly East AS
5. Lady Bay AS
6. Finish Manly (triangles)

Course 2 E,W 9.4 nm

1. Start Manly (triangles)
2. Cannae Point AS
3. Rocky Point AS
4. Edwards Beach AS
5. Cannae Point AS
6. Rocky Point AS
7. Edwards Beach AS (*)
8. Cannae Point AS
9. Grotto Point AS
10. Finish Manly (triangles)

Course 3 NE,SW 9.6nm

1. Start Manly (triangles)
2. Cannae Point AS
3. Chowder Bay South AS
4. Manly West AS (*)
5. Manly East AS
6. Cannae Point AS
7. Obelisk Bay AS
8. Finish Manly (triangles)

Course 4 NW,SE 9.5nm

1. Start Manly (triangles)
2. Lady Bay AS
3. Grotto Point AS
4. Lady Bay AS
5. Grotto Point AS
6. Manly West AS (*)
7. Manly East AS
8. Cannae Point AS
9. Manly West AS
10. Finish Manly (triangles)

Course 5 Tour 10.1nm

1. Start Manly (triangles)
2. Nielsen Park AS
3. Taylors Bay AS
4. Eastern Channel AS
5. Shark Island AS & Shark Island
6. Finish Manly (triangles)

Course 6 Triangle 9.5nm

1. Start Manly (triangles)
2. Cannae Point AS
3. Lady Bay AS
4. Neilson Park AS
5. Obelisk Bay AS
6. Lady Bay AS
7. Neilson Park AS
8. Finish Manly (triangles)

Course 7 Light Weather 6.0nm

1. Start Manly (triangles)
2. Cannae Point AS
3. Nielsen Park AS
4. Grotto Point AS
5. Finish Manly (triangles)

Course 8 The Sound 9.0nm

1. Start Manly (triangles)
2. Cannae Point AS
3. Lady Bay AS
4. Grotto Point AS
5. Cannae Point AS
6. Lady Bay AS (*)
7. Rocky Point AS
8. Edwards Beach AS
9. Grotto Point AS
10. Finish Manly (triangles)

(*) In addition to RRS32, some courses can be shortened at a mark indicated with (*). When, prior to the first boat rounding the mark indicated with (*), the S flag is displayed on the club flagstaff, then boats should round the mark and proceed directly to the finish. The Race Officer shall attempt to contact the fleet via VHF of course change.

A9 YACHT WINTER SERIES DIVISION 2 COURSES

All marks to starboard UNLESS OTHERWISE INDICATED (P). Australian Sailing (AS) marks are permanent laid yellow spar buoys. The courses 1 through 4 are approximately aligned with the wind directions indicated below. Courses 5-8 are interesting alternative courses that are not particular to wind direction. All distances are approximate.

Course 1 N,S 8.3nm

1. Start Manly (triangles)
2. Sow & Pigs Reef
3. Manly West AS (*)
4. Manly East AS
5. Lady Bay AS
6. Finish Manly (triangles)

Course 2 E,W 8.0nm

1. Start Manly (triangles)
2. Cannae Point AS
3. Grotto Point AS
4. Cannae Point AS
5. Rocky Point AS
6. Edwards Beach AS (*)
7. Cannae Point AS
8. Grotto Point AS
9. Finish Manly (triangles)

Course 3 NE,SW 8.0nm

1. Start Manly (triangles)
2. Cannae Point AS
3. Obelisk Bay AS
4. Manly West AS (*)
5. Manly East AS
6. Cannae Point AS
7. Obelisk Bay AS
8. Finish Manly (triangles)

Course 4 NW,SE 8.0nm

1. Start Manly (triangles)
2. Cannae Point AS
3. Grotto Point AS
4. Lady Bay AS
5. Grotto Point AS
6. Manly West AS (*)
7. Manly East AS
8. Cannae Point AS
9. Manly West AS
10. Finish Manly (triangles)

Course 5 Tour 9.2nm

1. Start Manly (triangles)
2. Nielsen Park AS
3. Taylors Bay AS
4. Chowder Bay South AS
5. Shark Island AS & Shark Island
6. Finish Manly (triangles)

Course 6 Triangle 8.2nm

1. Start Manly (triangles)
2. Cannae Point AS
3. Lady Bay AS
4. Neilson Park AS
5. Obelisk Bay AS
6. Lady Bay AS
7. Obelisk Bay AS
8. Finish Manly (triangles)

Course 7 Light Weather 5.0nm

1. Start Manly (triangles)
2. Cannae Point AS
3. Sow & Pigs Reef
4. Grotto Point AS
5. Finish Manly (triangles)

Course 8 The Sound 8.0nm

1. Start Manly (triangles)
2. Cannae Point AS
3. Grotto Point AS
4. Cannae Point AS
5. Lady Bay AS (*)
6. Rocky Point AS
7. Edwards Beach AS
8. Grotto Point AS
9. Finish Manly (triangles)

(*) In addition to RRS32, some courses can be shortened at a mark indicated with (*). When, prior to the first boat rounding the mark indicated with (*), the S flag is displayed on the club flagstaff, then boats should round the mark and proceed directly to the finish. The Race Officer shall attempt to notify the fleet via VHF of course change.

A10 YACHT MANLY SPRINT SERIES COURSES

An offset mark may optionally be placed approximately 25 to 100 metres from the windward mark, at an angle approximately 90 degrees from the direction of the windward leg. When an offset mark is laid, boats must round to port immediately after rounding mark 1 or 1A.

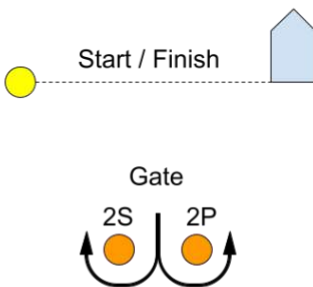
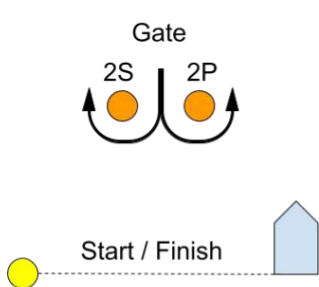
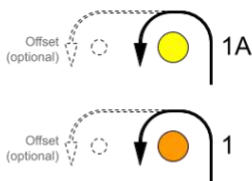
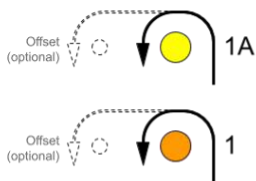

Courses 1, 2 & 3

Courses 4, 5 & 6

	Div 1	Div 2
Course 1:	Start 1A Finish	Start 1 Finish
Course 2:	Start 1A Gate 1A Finish	Start 1 Gate 1 Finish
Course 3:	Start 1A Gate 1A Gate 1A Finish	Start 1 Gate 1 Gate 1 Finish

	Div 1	Div 2
Course 4:	Start 1A Gate Finish	Start 1 Gate Finish
Course 5:	Start 1A Gate 1A Gate Finish	Start 1 Gate 1 Gate Finish
Course 6:	Start 1A Gate 1A Gate 1A Gate Finish	Start 1 Gate 1 Gate 1 Gate Finish

13. SPONSORS AND ADVERTISERS INDEX

SPONSORS		
SERVICE	SPONSOR	REFERENCE
Beverages	Pepper Tree Wines	Page 100
	Clarity Cru Wine Merchants	Page 93
Clothing	Helly Hansen	Page 119
Coffee	Seven Miles Coffee Roasters	Page 94 & 108
Dinghies and Tenders	Tahе Outdoors	Page 18
	Global Surf industries	Page 97
Electronic Security Solutions	KTRONICS	Page 76
Entertainment / Accommodation	Altitude the Lodge	Page 102
	Ashwood Katoomba	Page 65
	Manly Yacht Club Venue Hire	Page 24
	Pittwater Eco Adventures	Page 85
	Pittwater Eco YHA	Page 54
Moorings	Castlecrag Marine	Page 29
	Manly Boatshed	Page 15
	Treharne Moorings	Page 5
Printing	Print & Copy Works	Page 136
Sailing	Manly Sailing	Page 28
	Sailaway Sydney	Back inside cover
Sailmakers	Hood Sailmakers	Page 111
	Ian Short Sails	Page 116
	Scott Sails	Page 119
Services	Long Life Plumbing	Page 9
	Order Express	Page 47 & 96
	Wire Empire Electrical	Page 52
	Harts Battery Services	Page 86
	The Kitchen Maker	Front inside cover
Marine Services	Castlecrag Marine	Page 29
	One Stop Marine	Page 52
	Sydney Boat Works	Page 138



(02) 8966 9622 www.printcopyworks.com.au



SYDNEY BOAT WORKS

North Harbour Marina

At Sydney Boat Works, our team offer over 30 years of boat building and shipwright expertise to deliver customised care for your vessel.

Our shipwright services encompass scheduled maintenance, repairs, refurbishment, restoration, brightwork & custom projects to keep your vessel performing at its best.

Get in touch for a customised quote, or pop into the workshop for a yarn.

Mike Cassidy

M: 0405 815 888

E: mike@sydneyboatworks.com.au

W: www.sydneyboatworks.com.au



LOCATION OF HARBOUR MARKS

-  AP Flag Postponement
-  N Flag Abandoned
-  N + A Flag Abandoned all racing for the day
-  C Flag Alternate Start
-  L Flag Contact RC
-  P Flag Preparatory
-  X Flag Individual recall
-  General recall
-  S Flag Short course
-  On Station at Start
-  On Station at Finish
-  Q Flag Triangles finish
-  M Flag Missing Mark
-  1
-  2
-  D Flag Division 1
-  E Flag Division 2
- Emergency Services: 000
- Marine Rescue: VHF16
- Race Committee: VHF 72 99774949
- Harbour Control: VHF13



NAME	LAT	LONG	NAME	LAT	LONG
EB Edwards Beach	33 49.292s	151 15.242e	NP Nelson Park	33 50.945s	151 15.927e
RP Rocky Point	33 49.424s	151 15.299e	SI Shark Island	33 51.609s	151 15.572e
GP Grotto Point	33 49.052s	151 16.039e	RB Rose Bay	33 51.742s	151 15.978e
MW Manly West	33 48.173s	151 16.619e	PP Point Piper	33 51.758s	151 15.077e
ME Manly East	33 48.193s	151 16.731e	TB Taylors Bay	33 50.898s	151 14.922e
CP Cannae Point	33 48.819s	151 16.956e	CBS Chowder Bay South	33 50.533s	151 15.343e
LB Lady Bay	33 50.076s	151 16.620e	CBN Chowder Bay North	33 50.343s	151 15.613e
BB Beashel Buoy (Sow & Pigs)	33 50.332s	151 16.185e	OB Obelisk Bay	33 49.845s	151 15.981e
EC East Channel	33 50.439s	151 16.249e			
All marks to be rounded to startboard					
AS Yacht Rounding Marks are yellow cylindrical or spar shaped buoys and may be replaced with a different mark without warning.					



Unwind.
Explore.
Feel free.

- Try Sailing
- Intro to Yachting Course
- International Crew Course
- International Bareboat Skipper Course
- International Certificate of Competency (ICC)
- Club racing, harbour races & major regattas



MYC member
for 20+ years
Xavier: 0413 900 987
sailawaysydney.com.au